

**Always read the instructions before use**

# YOSHI<sup>®</sup> AWS D3 Yoshi Air Water System

## SERVICE MANUAL 8-10-13-16-20-25 HP

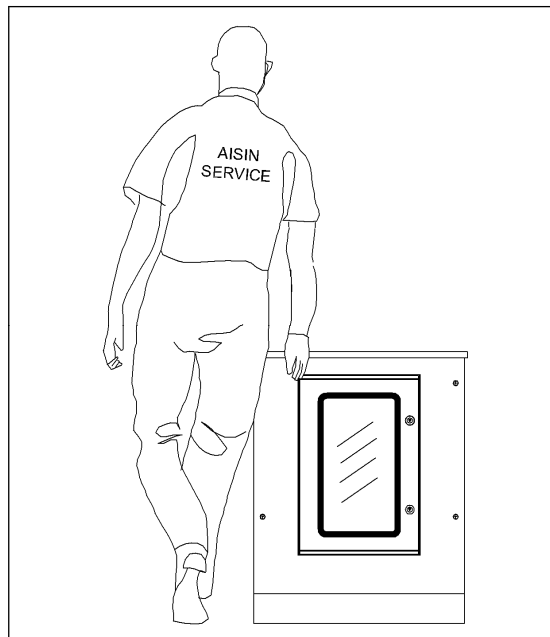

### Safety Precautions

The following safety warnings need to be respected in order to prevent injury and/or damage that might be caused by incorrect behaviour during repairs, inspections or maintenance to the Yoshi AWS Air Water System. Please read this manual with care and follow the instructions it contains.



#### CAUTION

Failure to abide by the instructions indicated with this symbol could cause serious damage to people or property.



#### Before commencing an inspection

1. Disconnect the power to the external control box of the YOSHI AWS to prevent the risk of electric shocks;
2. After disconnecting the current, wait for at least one minute to allow any residual electricity to dissipate.

Tecnocasa s.r.l. declines any responsibility for any damage whatsoever caused through the partial or superficial reading of the information in this manual. The drawings and information in this manual may change without notice.



# CONTENTS

1	AWS identification .....	65
	Electrical and water connections GHP-AWS .....	66
3	AWS unit specifications.....	67
4	Dimensions .....	69
5	Refrigerant system operating .....	70
5.1	<i>Cooling mode</i> .....	70
5.2	<i>Heating mode</i> .....	70
6	Control panel.....	72
6.1	<i>Using the control panel selection keypad</i> .....	72
6.2	<i>Key functions</i> .....	72
6.3	<i>Control panel root directory</i> .....	73
7	Switching the Yoshi AWS ducted unit on/off .....	74
8	Language selection .....	75
9	Menu .....	78
10	User mode.....	79
10.1	<i>Date and time menu</i> .....	80
10.2	<i>Heating/cooling mode settings (user mode menu)</i> .....	81
11	Programming operating times .....	82
11.1	<i>Timer programming menu</i> .....	82
11.2	<i>Timer setting</i> .....	83
11.3	<i>Time interval setting</i> .....	83
12	Setting the set point temperature .....	85
12.1	<i>T set heat (heating)</i> .....	85
12.2	<i>T set cool (cooling)</i> .....	86
13	Alarms .....	87
13.1	<i>Alarms menu</i> .....	87
13.2	<i>Alarms history menu</i> .....	88
13.3	<i>Alarms reset menu</i> .....	89
13.4	<i>AWS alarms list</i> .....	89
13.5	<i>GHP outdoor unit alarms list</i> .....	90
14	Service mode menu .....	92
14.1	<i>I/O menu (AWS input and output signals)</i> .....	93
14.1.1	<i>Analog input menu</i> .....	93
14.1.2	<i>Digital input menu</i> .....	95
14.1.3	<i>Digital outputs menu</i> .....	98

14.2	<i>Pump control</i> .....	100
14.3	<i>Mode selection</i> .....	101
14.4	<i>Toffset cooling</i> .....	101
14.5	<i>Toffset heating</i> .....	101
14.6	<i>Pump delay</i> .....	102
15	Disabling the flow switch alarm .....	103
16	Wiring diagrams .....	106
17	Relation between engine RPM and outside temperature.....	112
18	Contact specifications .....	118
19	Table temperature – sensor NTC resistor.....	119
20	Characteristics sensor gas and liquid pipe.....	120

## 1 AWS identification

Each AWS YOSHI can be traceable by model name and serial number. Aisin's authorised service centre is requested to store this information and to write it down at the commissioning in the maintenance booklet.

- Serial number is an alpha-numerical code that allows to retrieve information about the specifications of the unit.

UNIT	CAPACITY	SERIES	VERSION	PUMP
<b>AWS</b>	<b>20 HP</b>	<b>D</b>	<b>3</b>	<b>J</b>
	Shows the capacity of the GHP to be connected	Shows the series of the GHP to be connected	Shows the type of the AWS minor change	Shows whether the unit has a built in pump or not

- Model name is an alpha-numerical number that shows capacity and series of each unit.

Electronics	Heat exchanger type	Electric box type	Version	Expansion valve type	Pump type	Capacity	Serial number				
							0	0	5	2	6
<b>D</b>	<b>S</b>	<b>L</b>	<b>6</b>	<b>C</b>	<b>V</b>	<b>X</b>	<b>0</b>	<b>0</b>	<b>5</b>	<b>2</b>	<b>6</b>
AISIN DAIKIN	S: Swep O: Onda	L: Picchio E: Electron C: Castellani H: Stacchiotti		C: Carel E: Eliwell	N: Salmson V: Wilo J: No pompa	X: 8-10-13 HP W: 16-20-25 HP	This is a one-time used number. The same number can never be addressed to more than one unit.				

## 2 Electrical and water connections GHP-AWS

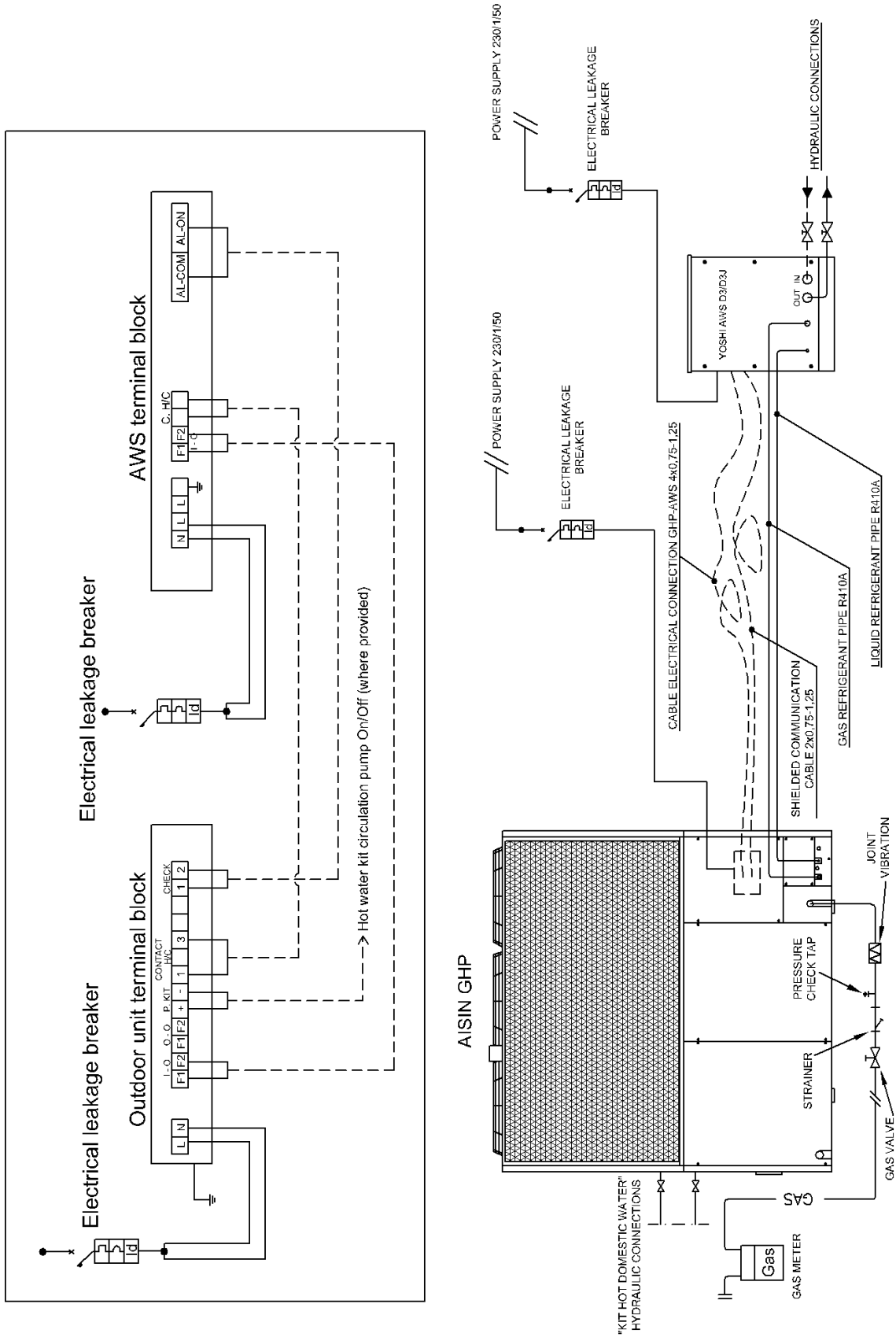

### 3 AWS unit specifications

All versions		AWS 8HP-D3 (D3J)	AWS 10HP-D3 (D3J)	AWS 13HP-D3 (D3J)	
Capacity code of the connected GHP outdoor unit		<b>P224</b>	<b>P280</b>	<b>P355</b>	
Rated cooling capacity*	kW (frig./h)	21,5 (18.490)	26,6 (22.876)	34,0 (29.240)	
Water temperature out - [in]	°C	7 – [11]	7 – [12]	7 – [12]	
Rated heating capacity **	kW (kcal/h)	23,5 (20.210)	30,0 (25.800)	38,0 (32.680)	
Water temperature out - [in]	°C	45,5 – [41]	45,5 – [40]	45,5 – [40]	
Flow rate		m <sup>3</sup> /h	4,5	6,0	
Version with Pump (AWS D3)	Power supply***	V/Ph/Hz	230/1/50		
	Power consumption	kW	0,83		
	Available static pressure	kPa	80	80	60
Version without Pump (AWS D3J)	Power supply	V/Ph/Hz	230/1/50		
	Maximum current	A	10		
Drop pressure plate heat exchanger		m.c.a.	3,3	3,3	4,6
Water circuit	Water pipes connection	Inch	2 (Each AWS unit is delivered with 2" nipples fittings to be installed if necessary)		
	Primary circuit pipes diameter	Inch	2 or higher (Each AWS unit is fitted with a 2" Y-shape filter to be installed on the primary circuit)		
Refrigerant circuit	Refrigerant gas connection (gas – liquid)	mm	28,6 – 12,7		
	GHP – AWS pipes diameter (gas – liquid)	mm	19,1 – 9,5 **** (12,7)	22,2 – 9,5 **** (12,7)	25,4 – 12,7 **** (15,88)
External dimensions and weight	Height	mm	915		
	Width	mm	710		
	Depth	mm	1020		
	With Pump/Without Pump	kg	164/153		
Connectable GHP outdoor units		Each AWS unit can be connected with a single AISIN GHP outdoor unit			

\* Rated cooling capacity is measured according to the following conditions: water outlet temperature 7°C; outdoor temperature 35°C DB

\*\* Rated heating capacity is measured according to the following conditions: water outlet temperature 47°C; outdoor temperature 7°C DB / 6°C WB

\*\*\* A version fitted with 230V, single phase, 60 Hz is available upon order.

\*\*\*\* If the distance between GHP and AWS exceeds 40 meters, increasing the size of the liquid pipe with a more larger diameter.

All versions		AWS 8HP-D3 (D3J)	AWS 10HP-D3 (D3J)	AWS 13HP-D3 (D3J)	
Capacity code of the connected GHP outdoor unit		<b>P224</b>	<b>P280</b>	<b>P355</b>	
Rated cooling capacity*	kW (frig./h)	43,0 (36.980)	53,5 (46.010)	67,5 (58.050)	
Water temperature out - [in]	°C	7 – [12]	7 – [12]	7 – [12]	
Rated heating capacity **	kW (kcal/h)	47,5 (40.850)	60,0 (51.600)	76,0 (65.360)	
Water temperature out - [in]	°C	45,5 – [40]	45,5 – [40]	45,5 – [40]	
Flow rate		m <sup>3</sup> /h	7,5	9,5	12
Version with Pump (AWS D3)	Power supply***	V/Ph/Hz	230/1/50		
	Power consumption	kW	1.3		
	Available static pressure	kPa.	100	80	60
Version without Pump (AWS D3J)	Power supply	V/Ph/Hz	230/1/50		
	Maximum current	A	10		
Drop pressure plate heat exchanger		m.c.a.	2,2	3,3	4,6
Water circuit	Water pipes connection	Inch	2 (Each AWS unit is delivered with 2" nipples fittings to be installed if necessary)		
	Primary circuit pipes diameter	Inch	2 or higher (Each AWS unit is fitted with a 2" Y-shape filter to be installed on the primary circuit)		
Refrigerant circuit	Refrigerant gas connection (gas – liquid)	mm	28,6 – 18,0		
	GHP – AWS pipes diameter (gas – liquid)	mm	28,6 – 12,7 **** (15,88)	28,6 – 15,88 **** (19,05)	35,0 – 15,88 **** (19,05)
External dimensions and weight	Height	mm	915		
	Width	mm	710		
	Depth	mm	1020		
	With Pump/Without Pump	kg	204/177		
Connectable GHP outdoor units		Each AWS unit can be connected with a single AISIN GHP outdoor unit			

\* Rated cooling capacity is measured according to the following conditions: water outlet temperature 7°C; outdoor temperature 35°C DB

\*\* Rated heating capacity is measured according to the following conditions: water outlet temperature 47°C; outdoor temperature 7°C DB / 6°C WB

\*\*\* A version fitted with 230V, single phase, 60 Hz is available upon order.

\*\*\*\* If the distance between GHP and AWS exceeds 40 meters, increasing the size of the liquid pipe with a more larger diameter.



## 4 Dimensions

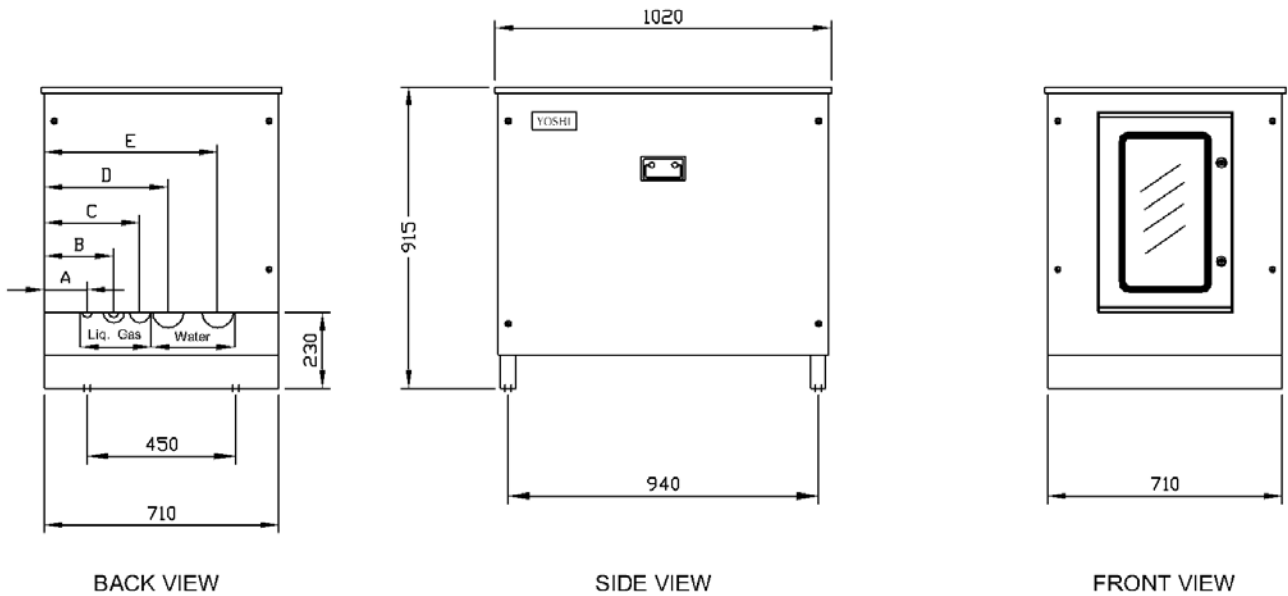

SPECIFICATIONS														
Water pipes connection	Inch	$\phi$ 2												
Primary circuit water pipes	Inch	$\phi$ 2 or higher												
Refrigerant gas connection	mm	(8 – 10 – 13) HP						(16 – 20 – 25) HP						
		Liquid			Gas			Liquid			Gas			
		12,7			28,6			18,0			28,6			
GHP – AWS Refrigerant gas line	mm	8 HP		10 HP		13 HP		16 HP		20 HP		25 HP		
		Liq.	Gas	Liq.	Gas	Liq.	Gas	Liq.	Gas	Liq.	Gas	Liq.	Gas	
		9,5	19,1	9,5	22,2	12,7	25,4	12,7	28,6	15,9	28,6	15,9	35	
Refrigerant and hydraulic pipes connection positions		Liquid (16-20-25)HP			Liquid (8-10-13) HP Gas (16-20-25) HP			Gas (8-10-13) HP			Water (8-10-13) HP (16-20-25) HP		Water (8-10-13) HP (16-20-25) HP	
		A			B			C			D		E	
	mm	130			210			290			375		525	
Dimensions (H x W x D)	mm	710 / 915 / 1020												

## 5 Refrigerant system operating

### 5.1 Cooling mode

The refrigerant (R410A) processed by the GHP flows through electronic expansion valve and enters the lower part of the AWS unit heat exchanger at low pressure. The gas evaporates in the plate heat exchanger by taking heat from the counter current water flow. It goes back to the GHP as overheated steam. The outdoor unit fans create an air flow through the heat exchanger and thus the refrigerant can condense.

At the same time, the water coming from the buffer tank is cooled and pumped again into the primary circuit by the AWS built in pump. Flow switch, pressure switch and anti freeze thermo sensor overlook the water temperature never to drop inside the heat exchanger. In fact, water may freeze and the heat exchanger can be damaged.

### 5.2 Heating mode

The refrigerant (R410A) processed by the GHP enters the upper part of the AWS unit heat exchanger as high pressure overheated steam. The gas condenses in the plate heat exchanger by ceasing heat to the co current water flow. It goes back to the GHP as high pressure liquid, through the bypass pipe. The two outdoor unit expansion valves divide the return flow, reducing its pressure. The GHP manages the evaporation through the heat exchanger and the heat recovery.

At the same time, the water coming from the buffer tank is heated and pumped again into the primary circuit by the AWS built in pump.

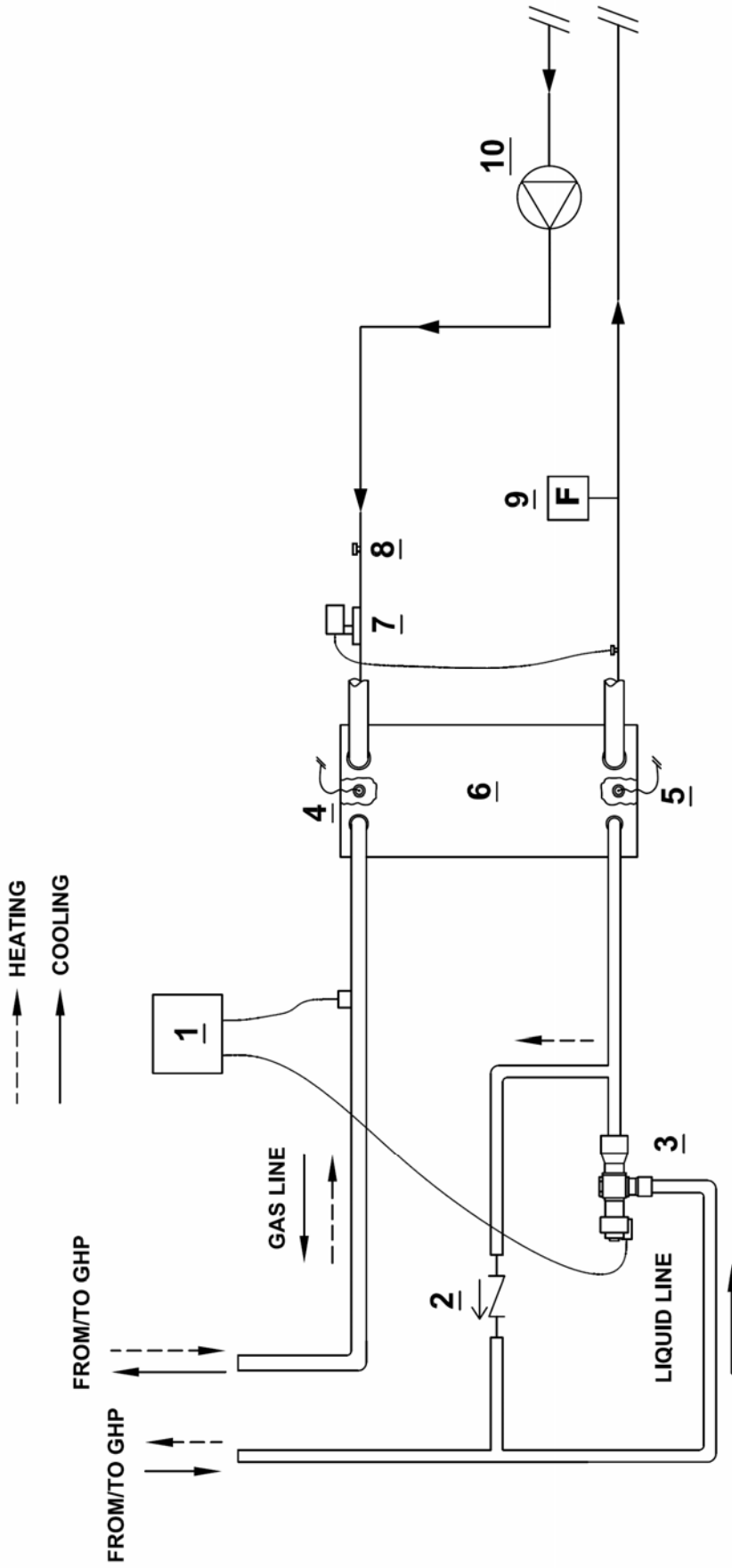

- 1) PID Controller
- 2) Check valve
- 3) Electronic expansion valve
- 4) Water inlet temperature probe
- 5) Water outlet temperature probe
- 6) Plate heat exchanger
- 7) Pressure difference switch
- 8) Air vent valve
- 9) Flow switch
- 10) Pump

## 6 Control panel

The YOSHI AWS has a control panel for adjustment and control, installed inside the control box and illustrated in the figure below.

The user has the possibility to select some options concerning the operation of the YOSHI AWS and to check the type of any anomalies.



### 6.1 Using the control panel selection keypad

To navigate inside the menu, use the following selection keypad

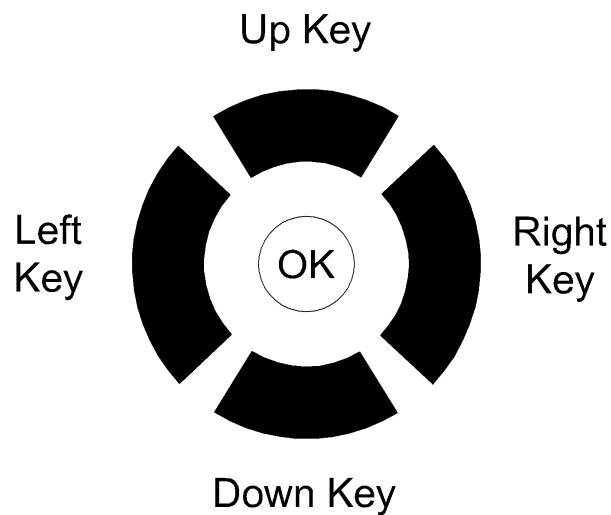

### 6.2 Key functions

Use the “Up” and “Down” keys to scroll through the list of options on the menu.

The “OK” button is used to select the required function and to confirm settings. The “Right” and “Left” keys are used to exit the selected mode.

### 6.3 Control panel root directory

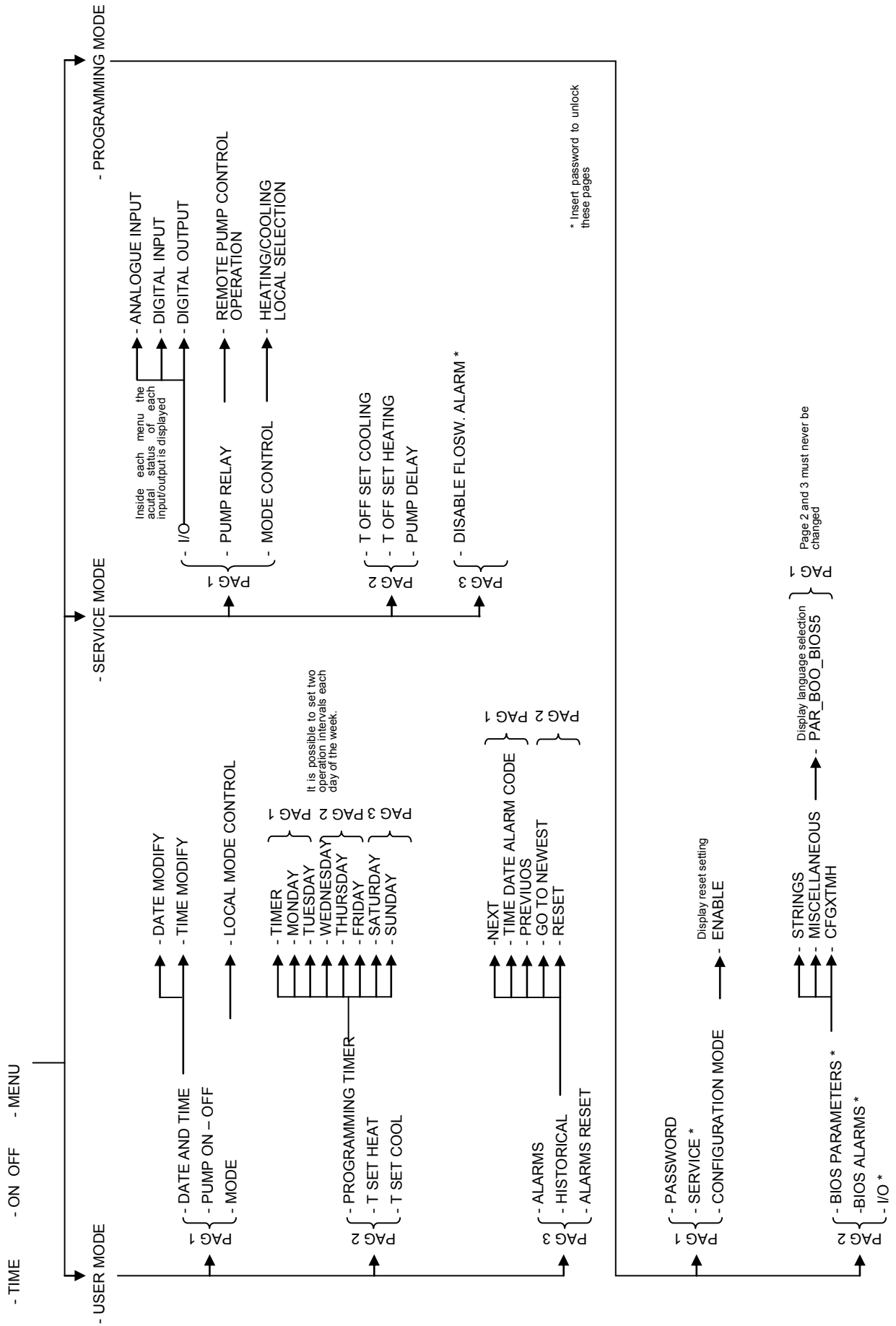

## 7 Switching the Yoshi AWS ducted unit on/off

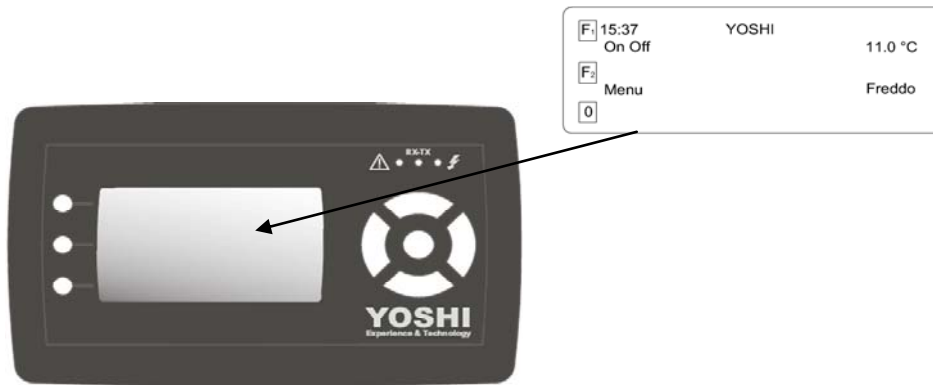

**To turn on the AWS** there are two ways: directly from the control panel installed on board of the module (**local procedure**), or via a switch located at a distance from the module (**remote procedure**).

The procedure will be selected by the service center at the first start of the hydronic module (see the paragraph **14.2 pump control** on page 100).

### Turning on the hydronic module

The AWS YOSHI raising the food switch, select the on / off the cursor highlighting the words in bold type, press the "OK". The red indicator lights indicated in the figure below.

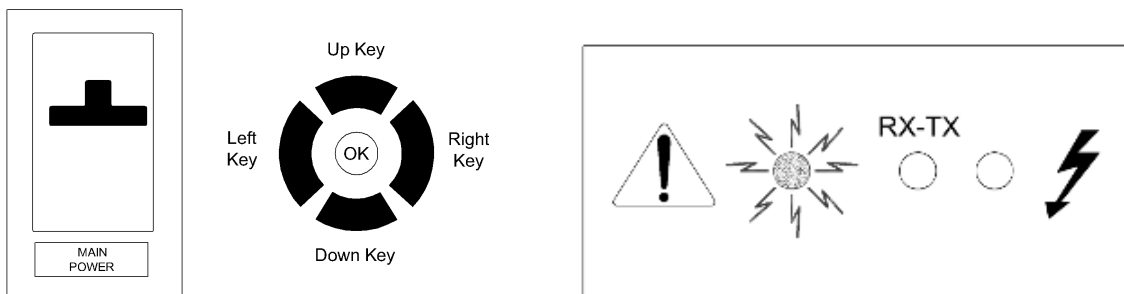

**To switch off the AWS**, select the on/off option again and press the "OK" key. The LED shown by the arrow will switch off.



### **Warning: electric shock hazard**

Electrical panel voltage. Protect yourself from unwanted incoming water in the event you need to remove the protective cover.

## 8 Language selection

To select the language, use the following screen to select the option “**Programming mode**” using the bottom key of the selection keypad. Confirm the setting with the “OK” key.

F <sub>1</sub>	MENU	01/01
	User mode	
F <sub>2</sub>	Service mode	
0	Programming mode	

This will open the following page.

F <sub>1</sub>	PROGRAMMING MOD	01/01
	Password	
F <sub>2</sub>	Configuration mode	
0		

Select “**Password**” with the “OK” key. This will open the following screen.

F <sub>1</sub>	PASSWORD
F <sub>2</sub>	*****
0	

Select the first asterisk \* with the “OK” key. When the asterisk starts to flash, press the top button of the selection keypad. The symbol + will appear in place of the asterisk.

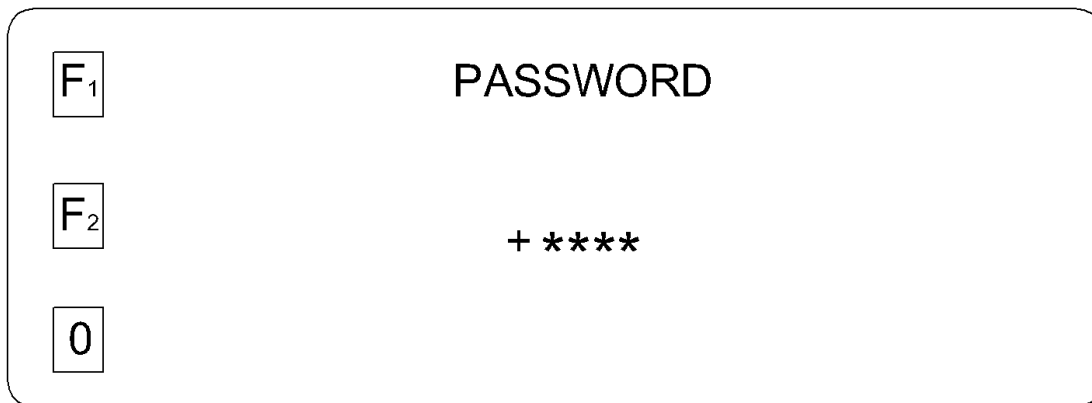

Press the “OK” key to confirm the selection. The display will show the following screen.

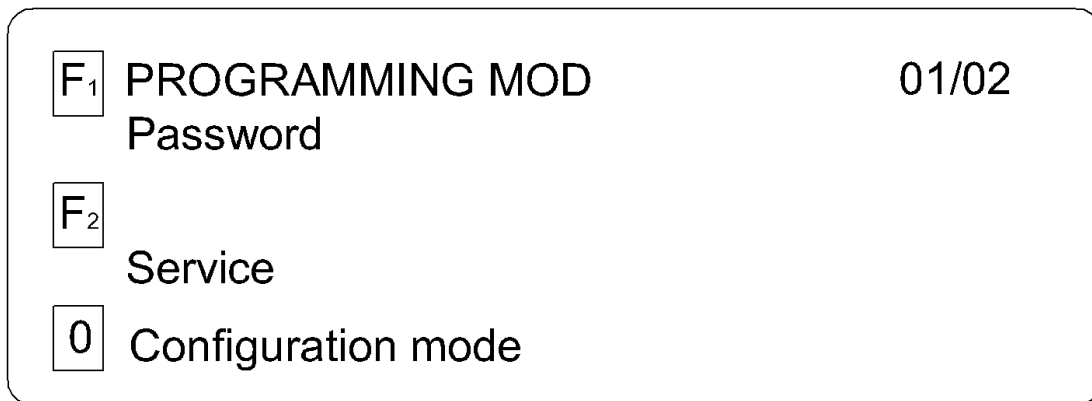

Select the next page 02/02.

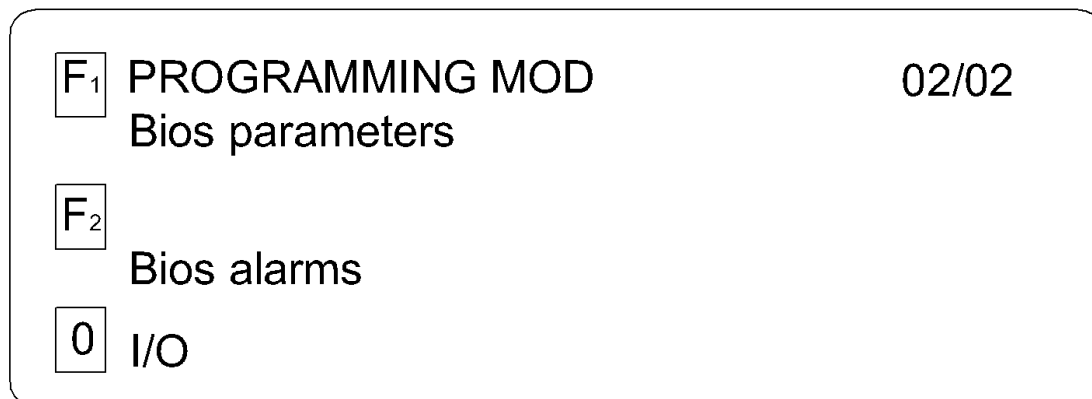



Select "Bios parameters" which will open the following screen.

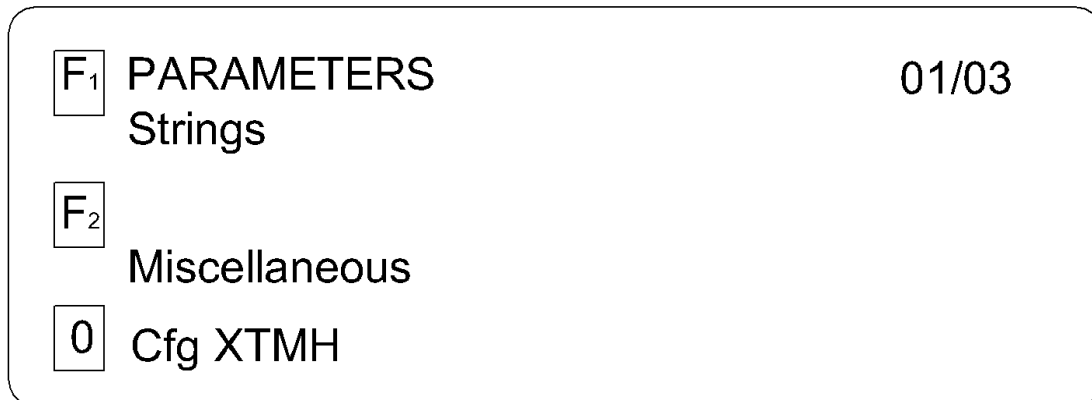

Select "Miscellaneous" to open the page.

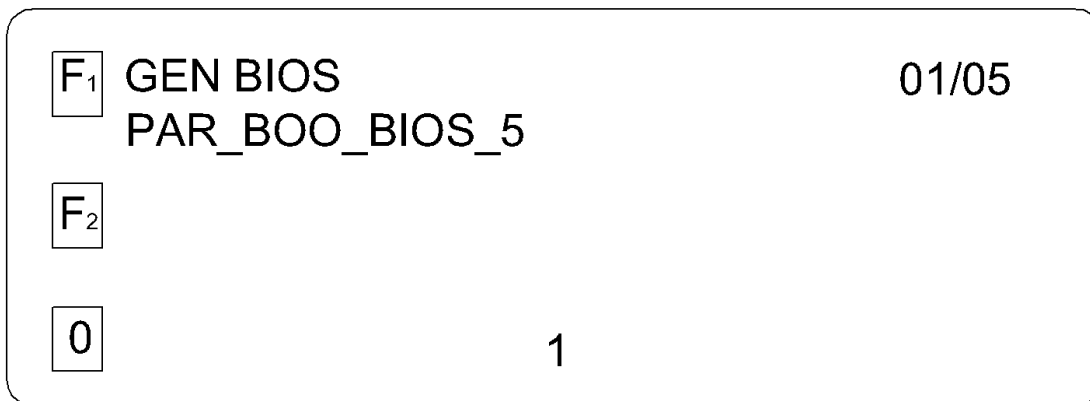

To select Italian as the language:

- Select the number "1" ;
- Press the bottom key on the selection keypad. The number "1" will be replaced by a zero "0" which will enable Italian as the language;
- Press the "OK" key to confirm the selection.

**Note: The English language is chosen selecting the number 1.**

## 9 Menu

The menu is opened from the following main screen which shows the time, the water's return temperature and the current operating mode (hot/cool).

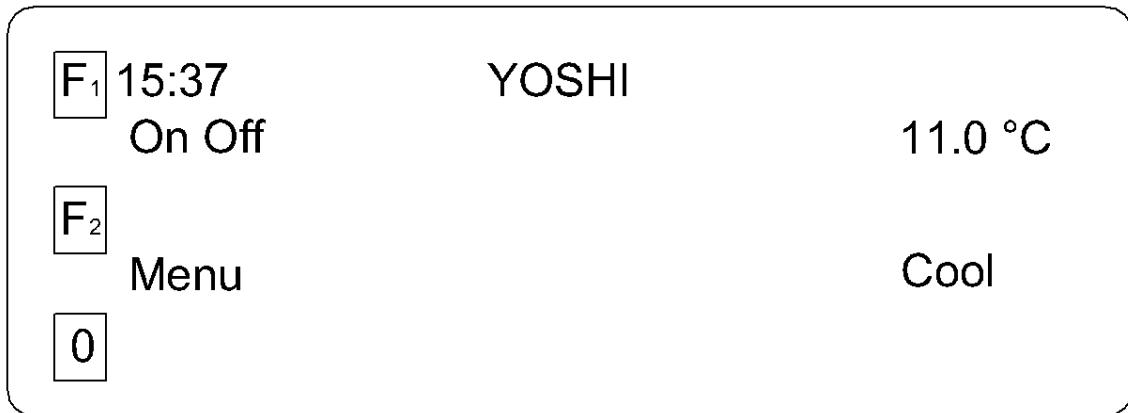

Use the button pad to select the “**Menu**” option, which will open a section comprised of the three following submenus:

- User mode
- Service mode
- Programming mode.

## 10 User mode

All of the adjustment and control options available to the user are described in this menu.

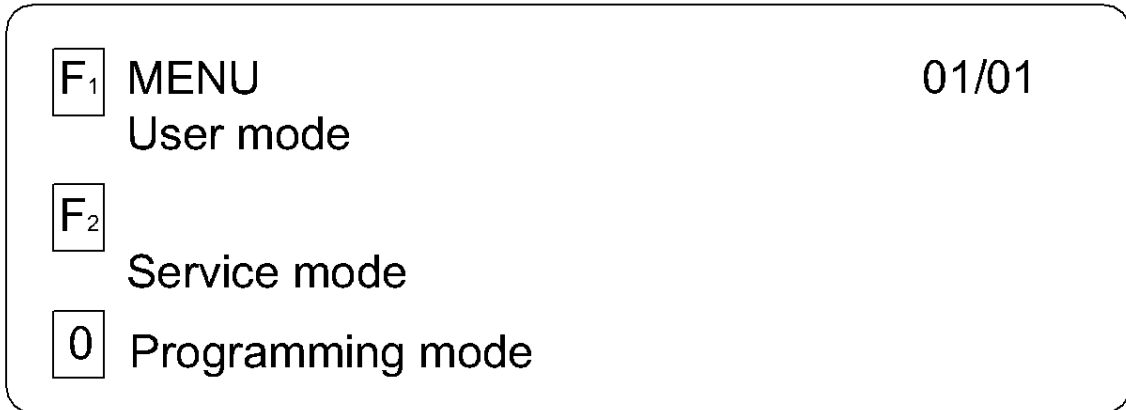

The “user mode” menu gives access to the following functions:

Screen 1/3

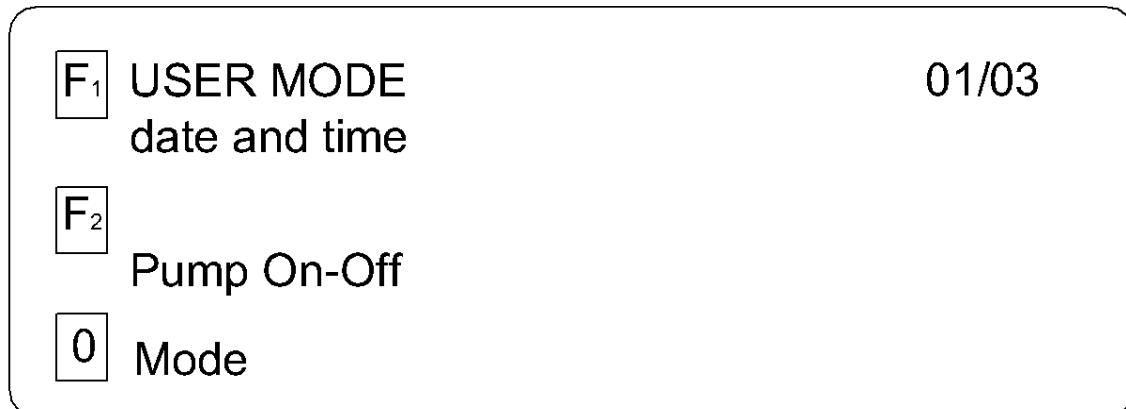

Screen 2/3

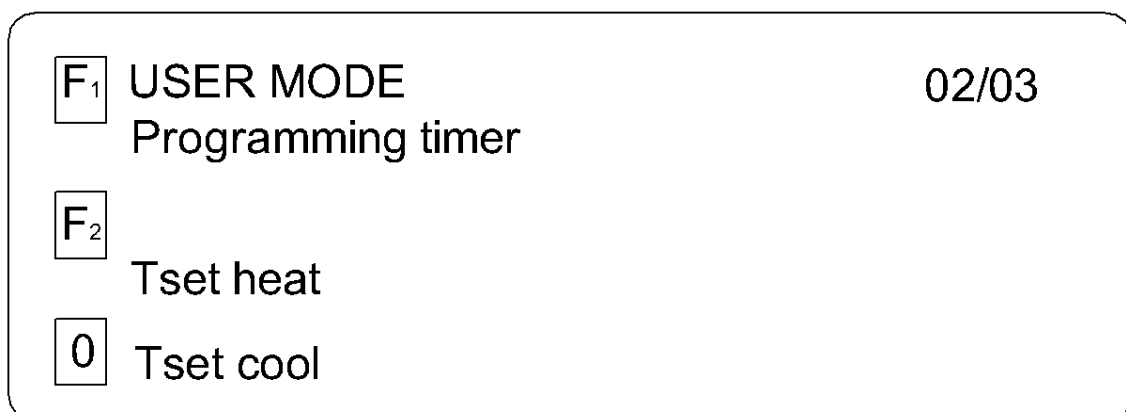

<b>F<sub>1</sub></b>	USER MODE	03/03
	Alarms	
<b>F<sub>2</sub></b>		
	Historical	
<b>0</b>	Alarms reset	

10.1 Date and time menu

<b>F<sub>1</sub></b>	DATE AND TIME	01/01
	29/06/10 09:33	
<b>F<sub>2</sub></b>		
	Date modify	
<b>0</b>	Time modify	

English

This function serves to set the date and time, as follows:

a)

<b>F<sub>1</sub></b>	DATE MODIFY	01/01
	GG	29
<b>F<sub>2</sub></b>		
	MM	June
<b>0</b>	AA	10

b)

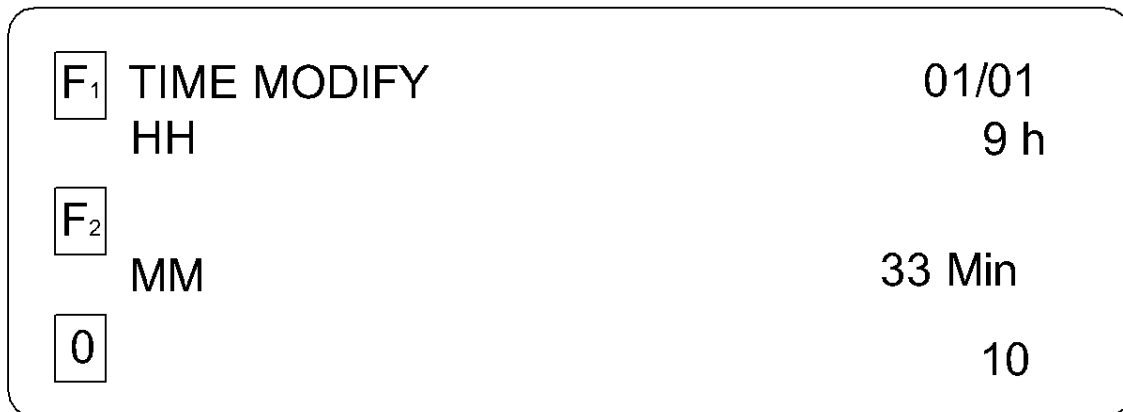

## **10.2 Heating/cooling mode settings (user mode menu)**

This function serves to choose the cooling or heating mode.

There are two ways to select the operating mode:

**Local mode control** directly from the control panel installed on board the unit.

To select the required mode, press the “OK” key. Use the up or down key on the pad to select the operating mode. Press “OK” again to confirm the chosen option.

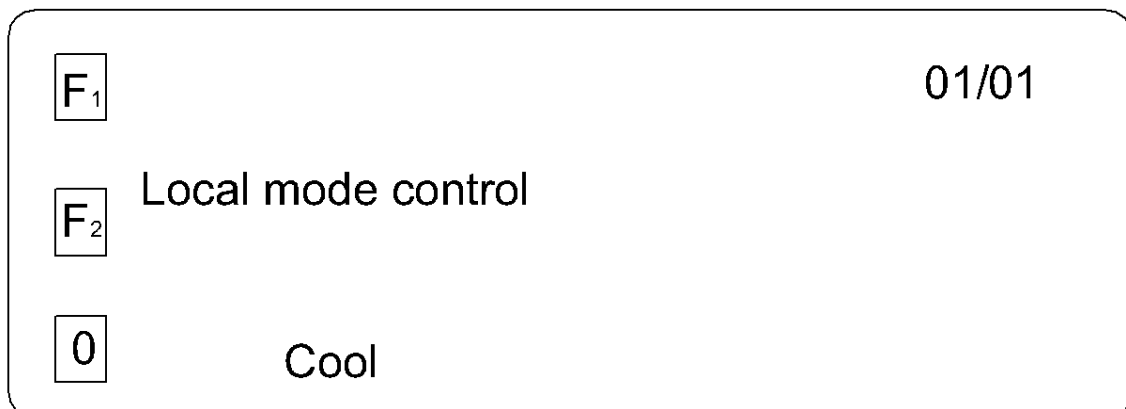

**Remote mode control** using a switch installed at a distance from the unit (see at page 74).

## 11 Programming operating times

### 11.1 Timer programming menu

This menu is comprised of the following three pages:

Page 1/3

<b>F<sub>1</sub></b>	<b>SETTINGS</b>	<b>01/03</b>
	Timer	Off
<b>F<sub>2</sub></b>	Monday	
<b>0</b>	Tuesday	

Page 2/3

<b>F<sub>1</sub></b>	<b>SETTINGS</b>	<b>02/03</b>
	Wednesday	
<b>F<sub>2</sub></b>	Thursday	
<b>0</b>	Friday	

Page 3/3

<b>F<sub>1</sub></b>	<b>SETTINGS</b>	<b>03/03</b>
	Saturday	
<b>F<sub>2</sub></b>	Sunday	
<b>0</b>		

### 11.2 Timer setting

Select the Timer function and the screen below will open

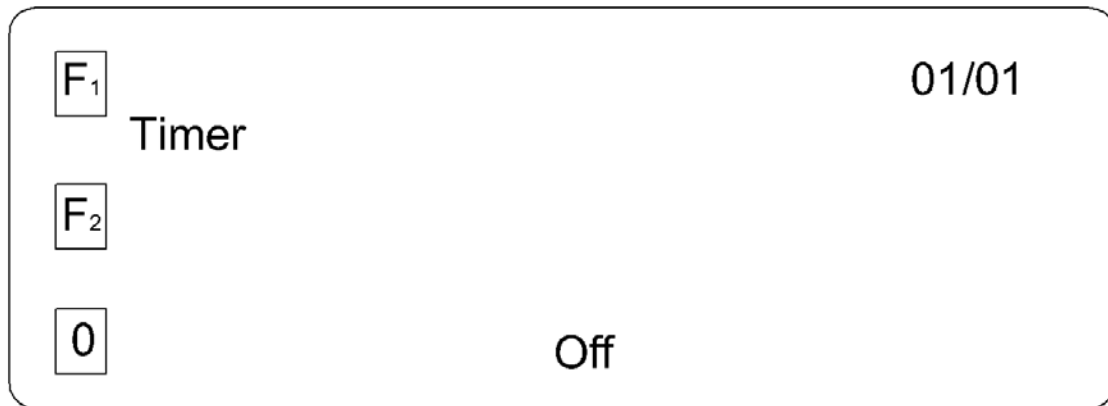

To control the on and off functions of the YOSHI AWS with the timer, use the "OK" key to select Off (timer disabled) or On (timer enabled).

Confirm the selection with the "OK" key.

### 11.3 Time interval setting

It is possible to set two time intervals for operation for every day of the week. Each interval will have a start and stop time for the AWS.

#### Time interval 1)

This interval is represented by the following screen: Period 1/2

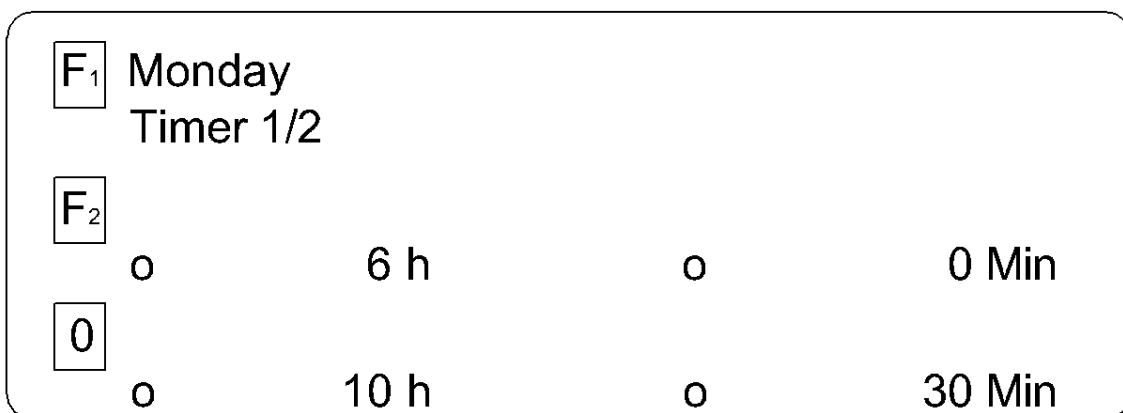

The **F<sub>2</sub>** line represents the starting time for the AWS. The **0** line represents the stopping time for the AWS.

To set the required hour, select the **o** symbol, press “OK”, and use the up and down keys on the keypad to select the time. Press the ”OK” key to confirm the setting.  
The same process is used to set the minutes.

**Time interval 2)**

This interval is represented by the following screen: Period 2/2

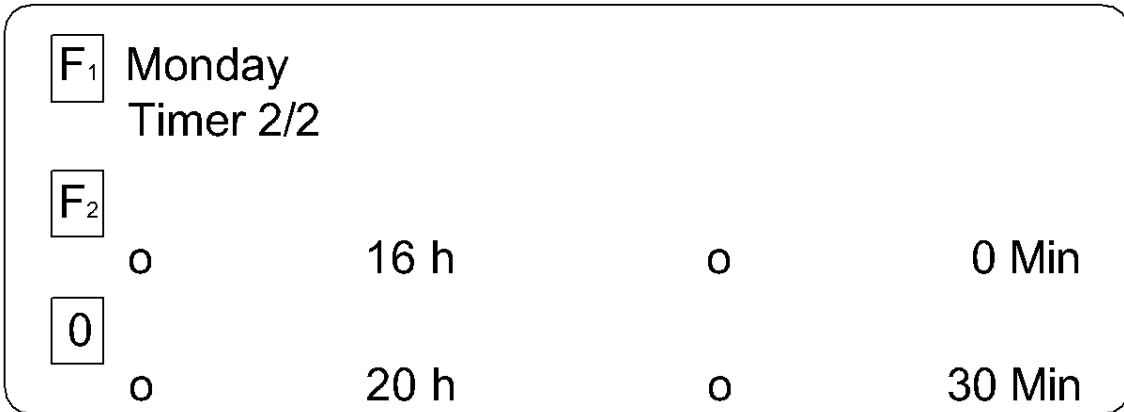

The **F<sub>2</sub>** line represents the starting time for the AWS. The **0** line represents the stopping time for the AWS.

To set the required hour, select the **o** symbol, press “OK”, and use the up and down keys on the keypad to select the time. Press the ”OK” key to confirm the setting.

The same process is used to set the minutes.

Repeat these steps to select the operating intervals for the remaining days of the week.

**Note: It is only possible to switch the AWS on/off manually (from the control panel or remote switch) if the timer is set to “Off” or during the times outside of the set operation intervals.**



## 12 Setting the set point temperature

The default settings for the thermostat set point are:

- COOL mode:  $T_{\text{set cool}} = 11^{\circ}\text{C}$  --  $\Delta T = 2^{\circ}\text{C}$
- HEAT:  $T_{\text{set heat}} = 42^{\circ}\text{C}$  --  $\Delta T = 2^{\circ}\text{C}$

### 12.1 T set heat (heating)

To set the set point temperature for heating, select the function “T set heat” from screen 02/03 of the “user mode menu” and the following screen will open

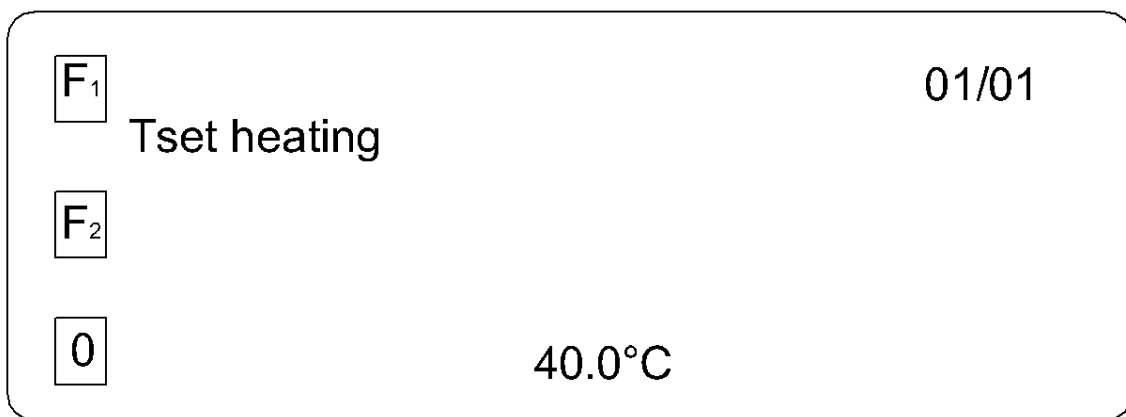

Select the highlighted temperature with the “OK key. Use the up and down keys on the keypad to increase or reduce the temperature on the screen.

Press the “OK” key to confirm the new temperature setting.

**Note: The T set temperature is a mathematical average between the set point temperature and the temperature at which the AWS restarts.**

Example

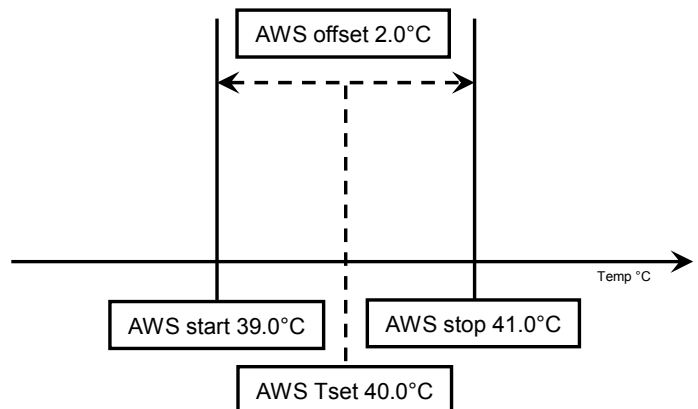
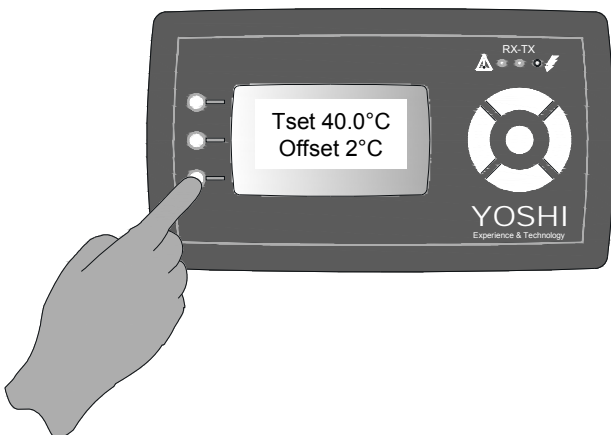

## 12.2 T set cool (cooling)

To set the set point temperature for cooling, select the function “T set cooling” from screen 02/03 of the “user mode menu” and the following screen will open

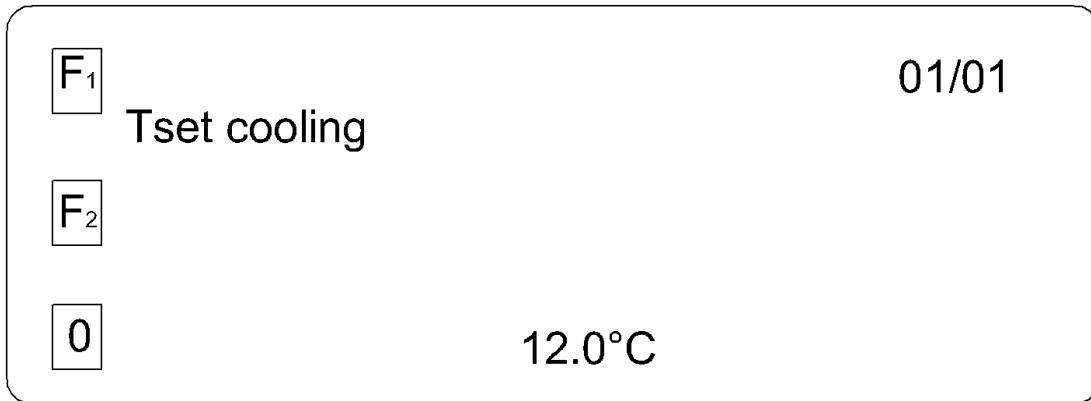

Select the highlighted temperature with the “OK key. Use the up and down keys on the keypad to increase or reduce the temperature on the screen.

Press the “OK” key to confirm the new temperature setting.

**Note: The T set temperature is a mathematical average between the set point temperature and the temperature at which the AWS restarts.**

## 13 Alarms

### 13.1 Alarms menu

In case of anomalies on the AISIN GHP outdoor unit or the YOSHI AWS, the LED shown by the arrow will start to flash. The type of alarm triggered by the anomaly will be shown on the control panel display.

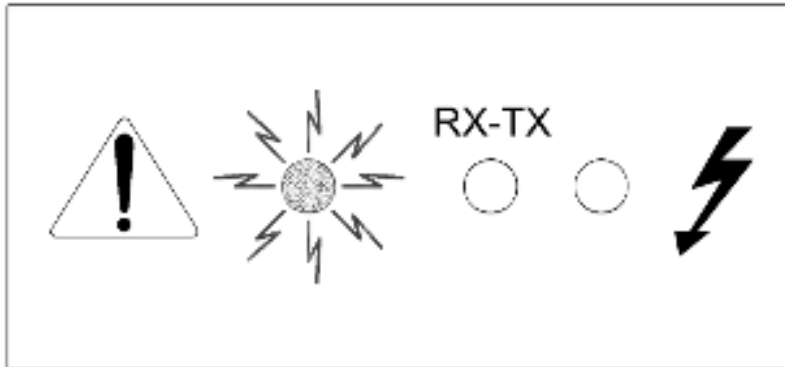

To see the list of alarms in progress, select the “Alarms” function in screen 03/03 of the USER MODE MENU and the following screen will open

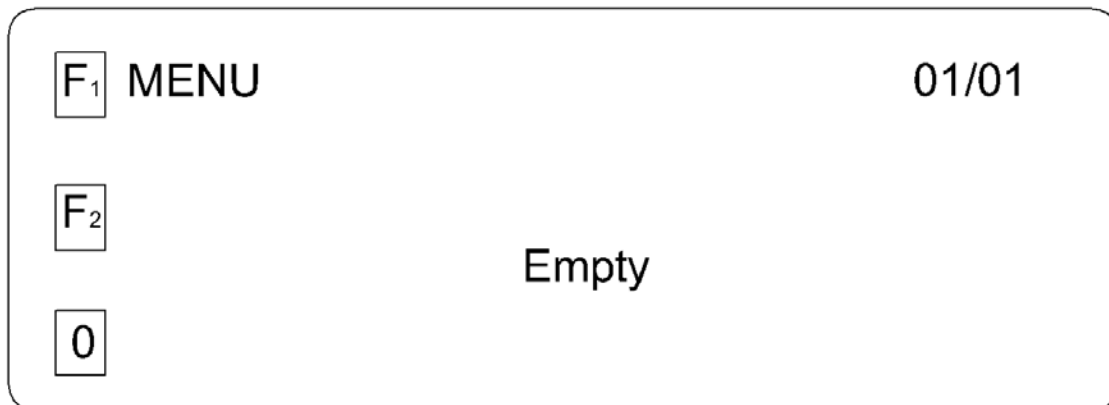

If no alarms have been recorded, then the display will read “Empty”.

**Note: See page 89 for the list of possible recorded alarms for the AWS.**

### 13.2 Alarms history menu

This menu contains the last 50 alarms. The menu is formed by two screens

#### Screen 1/2

This shows the time, date and alarm code for the anomaly that has occurred.

Select “next” or “previous” to view the following or previous alarm to the one shown on the screen.

<b>F<sub>1</sub></b>	Historical			01/02
<b>F<sub>2</sub></b>	Next			
	Time	Date	Alarm code	
<b>0</b>	Previous			

#### Screen 2/2

This section serves to request that the newest recorded alarm be displayed on screen 1/2 by selecting “Go to newest”.

The Reset option serves to delete the last 50 recorded alarms.

<b>F<sub>1</sub></b>	Historical			02/02
<b>F<sub>2</sub></b>	Go to newest			
	Reset			
<b>0</b>				

### 13.3 Alarms reset menu

To delete the list of alarms in progress, select the “Alarms reset” function on screen 03/03 of the USER MODE MENU and the screen shown below will appear.

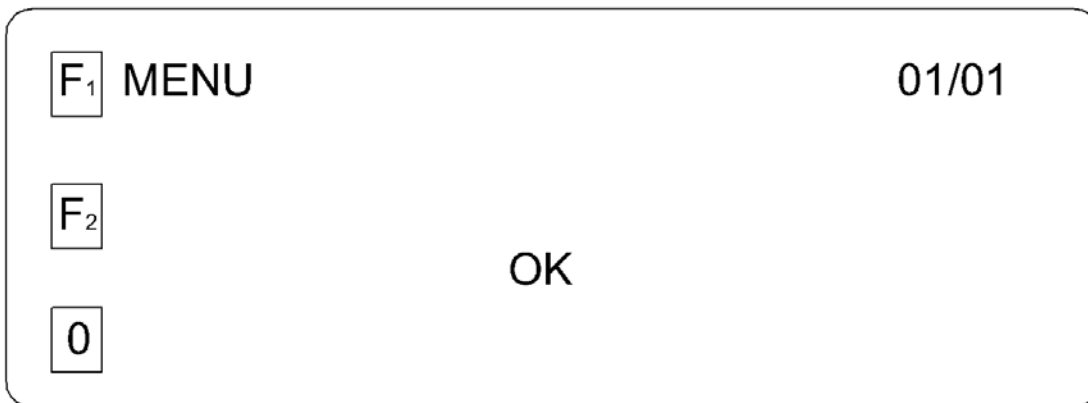

The word “OK” means that the list of alarms in progress has been deleted.

### 13.4 AWS alarms list

ALARM TYPE	ALARM CODE	POSSIBLE CAUSES	SOLUTIONS
Flow switch alarm	<b>A1S1</b>	<ul style="list-style-type: none"> <li>• Y-filter clogged</li> <li>• Capacity insufficient</li> </ul>	<ul style="list-style-type: none"> <li>• Clean the Y-filter</li> <li>• Check the pressure in the hydraulic circuit</li> <li>• Check the flow switch</li> </ul>
Pressure difference switch alarm	<b>A2S1</b>	<ul style="list-style-type: none"> <li>• Air in the system</li> <li>• Pump malfunction</li> </ul>	<ul style="list-style-type: none"> <li>• Remove the air</li> <li>• Replace the pump</li> <li>• Check the pressure differential switch (compare the state with the flow switch)</li> </ul>
GHP Alarm	<b>A3S1</b>		<ul style="list-style-type: none"> <li>• Check the code displayed on the GHP. Press UP for the current alarms and DOWN for those in STAN-BY</li> </ul>
Flow switch tamper alarm	<b>A4S1</b>		<ul style="list-style-type: none"> <li>• Check the wiring of the flow switch.</li> <li>• Check the operation of the flow switch.</li> <li>• Check the layout of plant (other pumps make circulate water when not expected)</li> </ul>
Antifreeze alarm	<b>A5S1</b>		<ul style="list-style-type: none"> <li>• Check the operation of the pump, the flow switch and pressure differential switch</li> <li>• Verify that the offset values in summer operation are not excessive</li> <li>• Check the temperature probes and their wiring</li> </ul>
Return temperature probe alarm	<b>A6S1</b>		<ul style="list-style-type: none"> <li>• Check the probe and the wiring</li> </ul>
Antifreeze temperature probe alarm	<b>A7S1</b>		<ul style="list-style-type: none"> <li>• Check the probe and the wiring</li> </ul>
Expansion valve driver alarm	<b>A8S1</b>		<ul style="list-style-type: none"> <li>• Use the Carel display. Press "help" and check which component is in alarm</li> </ul>

### 13.5 GHP outdoor unit alarms list

All of the anomalies that can be seen on the remote control display are listed below. In case of anomaly, contact the Aisin Authorised Technical Assistance Service responsible for maintenance on the GHP outdoor unit.

R/C AWS	Blinking indication (ON doesn't blink) (OFF led off)			GHP outdoor unit display	Type of failure	Possible cause
	Led ON/OFF	TEST Disp.	Unit No.			
A0	X	X	X	63-n	External input	<ul style="list-style-type: none"> <li>External protection input signal stops the unit</li> <li>Remote controller local setting failure</li> </ul>
A1	X	X	X	20-n	Indoor unit PC board	<ul style="list-style-type: none"> <li>PC board defective</li> <li>EEPROM setting error</li> </ul>
A3	X	X	X	95-n	Drain lines - AWS flow switch	<ul style="list-style-type: none"> <li>Direct Expansion version – indoor unit drain pump malfunction .</li> <li>AWS version – flow switch or antifreeze thermostat switched off.</li> </ul>
A6	X	X	X	15-n	Indoor unit fan motor	<ul style="list-style-type: none"> <li>Fan motor blocked</li> <li>Harness disconnection</li> </ul>
A7	ON	X	X	35-n	Indoor unit swing flap motor	<ul style="list-style-type: none"> <li>Swing flap motor malfunction</li> <li>Cam mechanism failure</li> </ul>
A9	X	X	X	21-n	Indoor unit PC board	<ul style="list-style-type: none"> <li>LEV malfunction</li> <li>Harness disconnection</li> </ul>
AF	ON	OFF	X	30-n	Drain pipe	<ul style="list-style-type: none"> <li>Improper drain piping installation (inverse draft)</li> <li>Pipe clogged</li> </ul>
AH	ON	OFF	X	31-n	Air cleaning device	<ul style="list-style-type: none"> <li>Indoor unit circuit boar malfunction</li> <li>Air cleaning device failure (optional)</li> </ul>
AJ	X	X	X	22-n	Capacity setting	<ul style="list-style-type: none"> <li>Capacity setting failure</li> <li>Missing capacity setting adapter (replacement of PCB)</li> </ul>
C4	X	X	X	18-n	Indoor unit temperature sensors	<ul style="list-style-type: none"> <li>Heat exchanger temperature sensor failure</li> <li>Improper harness connection</li> </ul>
C5	X	X	X	19-n		<ul style="list-style-type: none"> <li>Gas pipe temperature sensor failure</li> <li>Improper harness connection</li> </ul>
C9	X	X	X	97-n		<ul style="list-style-type: none"> <li>Direct Expansion version - Intake air temperature sensor failure</li> <li>AWS version – Resistors group failure</li> <li>Improper harness connection</li> </ul>
CA	X	X	X	98-n		<ul style="list-style-type: none"> <li>Exhaust air temperature sensor failure</li> <li>Improper harness connection</li> </ul>
CJ	ON	OFF	X	17-n	R/C temperature sensor	<ul style="list-style-type: none"> <li>R/C temperature sensor failure</li> <li>Improper harness connection</li> </ul>
U3	X	X	X	-	Test run	<ul style="list-style-type: none"> <li>Test run operation</li> </ul>
U4	X	X	X	-	Communication	<ul style="list-style-type: none"> <li>Outdoor unit power supply OFF</li> <li>Outdoor unit – indoor unit transmission error</li> </ul>
U5	X	X	X	1-n	Communication	<ul style="list-style-type: none"> <li>Duplicating main remote controller connection</li> <li>Transmission error</li> </ul>
	OFF	ON	OFF	-	Remote controller PC board	<ul style="list-style-type: none"> <li>Remote controller PC board failure</li> <li>Remote controller setting failure</li> </ul>
U8	X	X	OFF	-	Remote controller PC board	<ul style="list-style-type: none"> <li>Transmission error between main and sub remote controller</li> </ul>
U9	X	X	X	-	Communication	<ul style="list-style-type: none"> <li>Transmission error between two indoor units</li> <li>Transmission error between outdoor and indoor unit</li> </ul>
UC	ON	ON	ON	36-n	Central remote controller	<ul style="list-style-type: none"> <li>Address duplication of central remote controller</li> <li>Air-net address duplication of indoor units</li> </ul>
UE	X	X	X	23-n		<ul style="list-style-type: none"> <li>Transmission error between indoor unit and central remote controller</li> </ul>
UF	X	X	X	24-n	Communication	<ul style="list-style-type: none"> <li>Communication error between indoor and outdoor unit</li> <li>Improper wiring</li> </ul>
UH	X	X	X	-		<ul style="list-style-type: none"> <li>Indoor unit address setting failure</li> </ul>
E1	X	X	X	40-0~2		Outdoor unit PC board
	X	X	X	84-3,4	<ul style="list-style-type: none"> <li>Outdoor unit PC board malfunction</li> <li>Transmission error between microcomputer</li> </ul>	
E3	X	X	X	86-0	Operation failure	<ul style="list-style-type: none"> <li>Refrigerant High pressure alarm</li> </ul>
E4	X	X	X	88-0		<ul style="list-style-type: none"> <li>Refrigerant Low pressure alarm</li> </ul>
E7	X	OFF	X	86-10~23	Outdoor unit fan	<ul style="list-style-type: none"> <li>Heat exchanger fan (1,2,3) failure</li> <li>DCBL board failure</li> </ul>

EA	X	X	X	57-0	4-way valve	<ul style="list-style-type: none"> <li>4-way valve failure</li> <li>Harness disconnection</li> </ul>
EC	X	X	X	80-0	Operation failure	<ul style="list-style-type: none"> <li>Engine coolant overheating (temperature &gt;105°C)</li> </ul>
EH	X	X	X	80-10~30	Engine coolant pump	<ul style="list-style-type: none"> <li>Engine coolant pump failure</li> <li>DCBL board failure</li> </ul>
F3	X	X	X	91-0	Operation failure	<ul style="list-style-type: none"> <li>Compressor discharge temperature too high (&gt;120°C)</li> </ul>
F4	X	X	X	87-0,2		<ul style="list-style-type: none"> <li>Compressor intake temperature too high (&gt; 40°C)</li> </ul>
FE	X	X	X	81-0	Engine oil	<ul style="list-style-type: none"> <li>Abnormal engine oil pressure</li> <li>Engine oil level insufficient</li> </ul>
FF	X	X	X	58-0	Compressor oil	<ul style="list-style-type: none"> <li>Refrigerant oil supply valve failure</li> <li>Improper harness connection</li> </ul>
FJ	X	X	X	47-0	Catalyser	<ul style="list-style-type: none"> <li>Catalyser overheating (where provided)</li> </ul>
H3	X	X	X	76-0	High pressure switch	<ul style="list-style-type: none"> <li>High pressure switch malfunction</li> <li>Improper harness connection</li> </ul>
H4	X	X	X	88-2	Low pressure switch	<ul style="list-style-type: none"> <li>Low pressure switch malfunction</li> <li>Improper harness connection</li> </ul>
H9	X	X	X	61-0	Outdoor unit temperature sensors	<ul style="list-style-type: none"> <li>Outdoor temperature sensor malfunction</li> <li>Improper harness connection</li> </ul>
H9	X	X	X	61-1		<ul style="list-style-type: none"> <li>Outdoor temperature sensor short circuit</li> </ul>
HC	X	X	X	70-0		<ul style="list-style-type: none"> <li>Engine coolant temperature sensor malfunction</li> <li>Improper harness connection</li> </ul>
HC	X	X	X	80-1		<ul style="list-style-type: none"> <li>Engine coolant temperature sensor short circuit</li> </ul>
HJ	X	X	X	80-2	Engine coolant	<ul style="list-style-type: none"> <li>Engine coolant level insufficient</li> </ul>
HF	X	OFF	X	EE-0	Maintenance	<ul style="list-style-type: none"> <li>Periodic maintenance alert</li> </ul>
J3	X	X	X	78-1~5	Outdoor unit temperature sensors	<ul style="list-style-type: none"> <li>Compressor discharge temp sensor disconnected</li> </ul>
	X	X	X	91-2~7		<ul style="list-style-type: none"> <li>Compressor discharge temp sensor short circuit</li> </ul>
J4	X	X	X	54-0		<ul style="list-style-type: none"> <li>Super cooling heat ex. temp. sensor disconnected</li> </ul>
	X	X	X	54-1		<ul style="list-style-type: none"> <li>Super cooling heat ex. temp. sensor short circuit</li> </ul>
	X	X	X	55-0,1		<ul style="list-style-type: none"> <li>Accumulator outlet temp. sensor disconnected</li> </ul>
J5	X	X	X	55-2,3		<ul style="list-style-type: none"> <li>Accumulator outlet temp. sensor short circuit</li> </ul>
	X	X	X	53-0,1		<ul style="list-style-type: none"> <li>Compressor intake temp. sensor disconnected</li> </ul>
J6	X	X	X	53-2,3		<ul style="list-style-type: none"> <li>Compressor intake temp. sensor short circuit</li> </ul>
	X	X	X	65-0		<ul style="list-style-type: none"> <li>Heat exchanger liquid pipe temp. sensor disconnected</li> <li>Improper harness connection</li> </ul>
J7	X	X	X	65-2		<ul style="list-style-type: none"> <li>Heat exchanger liquid pipe temp. sensor short circuit</li> </ul>
	X	X	X	66-0		<ul style="list-style-type: none"> <li>Sub heat exchanger liquid pipe temp. sensor disconnected</li> </ul>
J8	X	X	X	66-1		<ul style="list-style-type: none"> <li>Sub heat exchanger liquid pipe temp. sensor short circuit</li> </ul>
	X	X	X	67-0		<ul style="list-style-type: none"> <li>Outdoor liquid pipe temp. sensor disconnected</li> </ul>
JA	X	X	X	67-2		<ul style="list-style-type: none"> <li>Outdoor liquid pipe temp. sensor short circuit</li> </ul>
	X	X	X	73-0,1	<ul style="list-style-type: none"> <li>High pressure sensor malfunction</li> </ul>	
JC	X	X	X	88-4	<ul style="list-style-type: none"> <li>Low pressure sensor malfunction</li> </ul>	
JE	X	X	X	71-0	Oil pressure sw.	<ul style="list-style-type: none"> <li>Oil pressure switch disconnected</li> </ul>
JJ	X	X	X	72-0	Outdoor unit temperature sensors	<ul style="list-style-type: none"> <li>Engine room temp. sensor disconnected</li> </ul>
	X	X	X	72-1		<ul style="list-style-type: none"> <li>Engine room temp. sensor short circuit</li> </ul>
	X	X	X	72-6		<ul style="list-style-type: none"> <li>Catalyser temp. sensor disconnected</li> </ul>
LE	X	X	X	75-1~3	Igniter voltage	<ul style="list-style-type: none"> <li>Igniter voltage too low or too high</li> </ul>
LF	X	X	X	84-0	Operation failure	<ul style="list-style-type: none"> <li>Engine start failure – missing supply gas</li> </ul>
LJ	X	X	X	75-0		<ul style="list-style-type: none"> <li>Unwanted engine stop</li> </ul>
P8	X	X	X	74-1~4 74-6 82-0~1	Engine	<ul style="list-style-type: none"> <li>Insufficient starting engine speed (starter failure)</li> <li>Abnormal engine speed (gas mixer failure)</li> </ul>
PE	X	X	X	74-7	Gas valves	<ul style="list-style-type: none"> <li>Supply electro magnetic gas valves failure</li> </ul>
PF	X	X	X	60-0	Starter	<ul style="list-style-type: none"> <li>Starter failure</li> </ul>
U0	X	X	X	88-5	Ref. Piping	<ul style="list-style-type: none"> <li>Refrigerant gas empty</li> </ul>
					Communication	<ul style="list-style-type: none"> <li>master / slave outdoor unit communication failure</li> </ul>
U7	X	X	X	4-0~6	Indoor unit number	<ul style="list-style-type: none"> <li>Over connection of capacity units</li> <li>Too many indoor units connected</li> </ul>
UA	X	X	X	43-0,1 44-n	Operation failure	<ul style="list-style-type: none"> <li>Compressor discharge temperature too high (&gt;120°C)</li> </ul>

## 14 Service mode menu

This menu is comprised of six submenus:

I/O (AWS input and output signals)

Pump relay

Mode control

T offset cooling

T offset heating

Pump delay.

The menus are shown on the two following pages

1)

<b>F<sub>1</sub></b>	<b>SERVICE MODE</b>	<b>01/02</b>
	I/O	
<b>F<sub>2</sub></b>	Pump relay	
<b>0</b>	Mode control	

2)

<b>F<sub>1</sub></b>	<b>SERVICE MODE</b>	<b>02/02</b>
	T off set cooling	
<b>F<sub>2</sub></b>	T off set heating	
<b>0</b>	Pump delay	



## 14.1 I/O menu (AWS input and output signals)

This menu is shown on the following screen

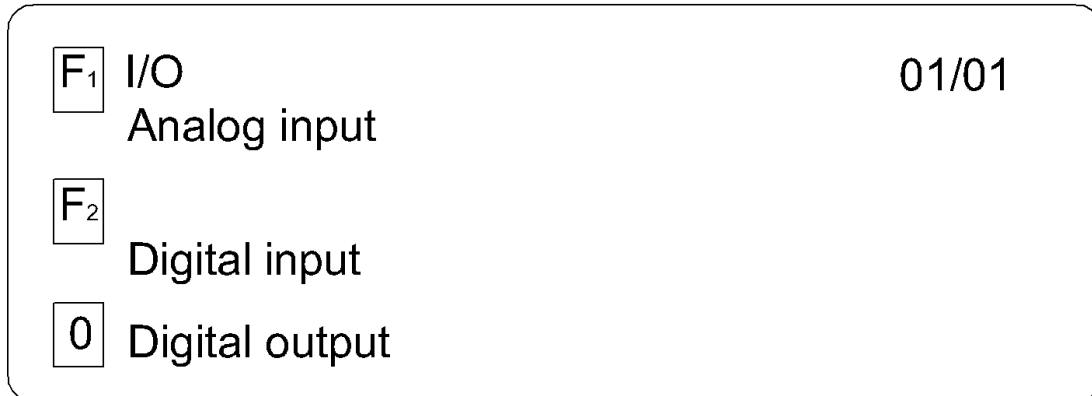

### 14.1.1 Analog input menu

The instructions for this submenu are shown on three screens

1) The display shows the return water temperature.

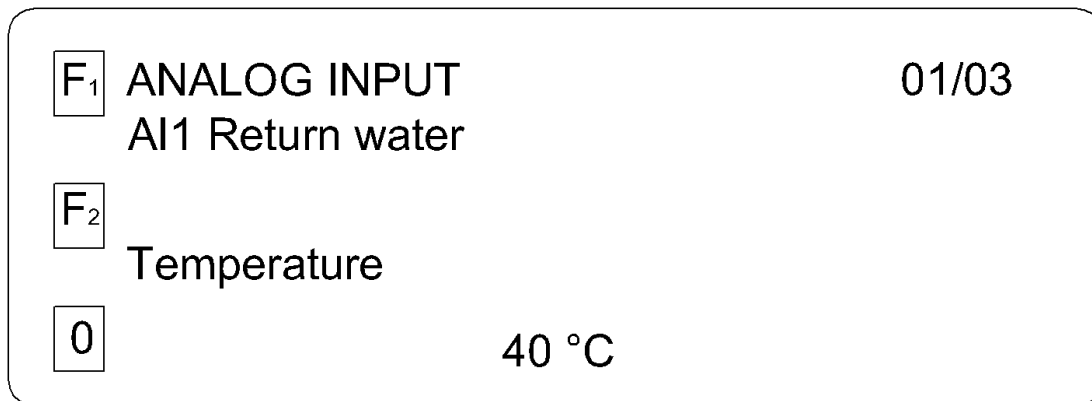

2) The temperature listed on the display as “antifreeze” shows the water delivery temperature.

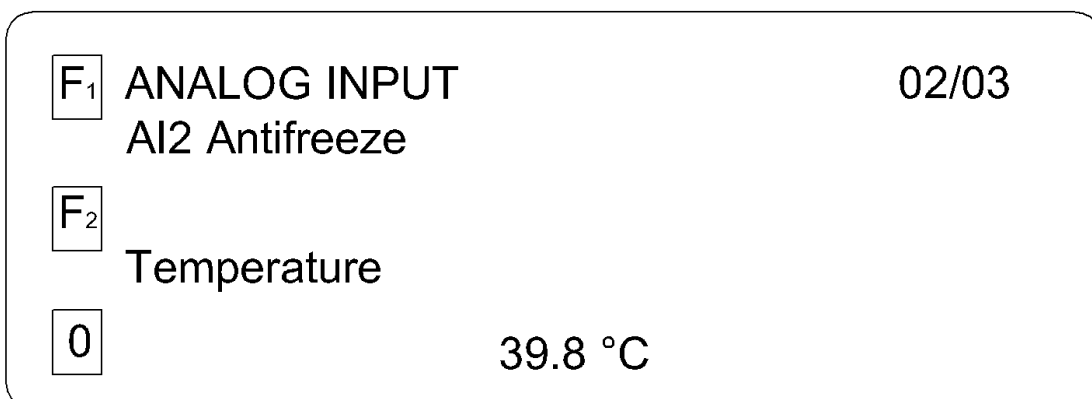

### 3) Dynamic setpoint

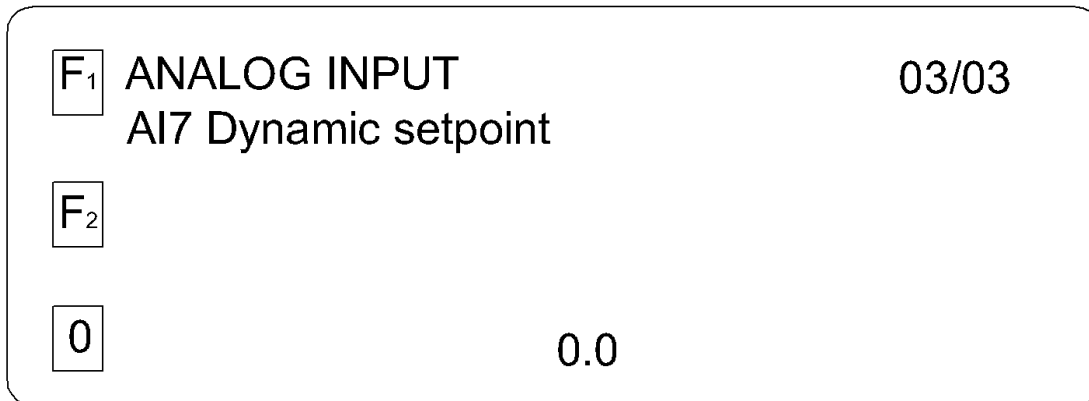

It is possible to set a variable setpoint temperature according to a voltage between 5 and 10 Volts, sent to the terminals of the AWS marked “SET-” and “SET+”.

The “dynamic setpoint” screen shows the current voltage level. If this is less than 5, then the manually set setpoint is enabled. If the voltage level shown is more than or equal to 5, then the dynamic set point is enabled.

The relationship between incoming voltage and T, the dynamic set point is the following:

#### **Cooling**

$$T_{\text{set point}} = (X - 5) * 1.8 + 11$$

#### **Heating**

$$T_{\text{set point}} = (X - 5) * 1.6 + 35$$

The variable x has values from 5 to 10 Volts.

### 14.1.2 Digital input menu

The instructions for this submenu are shown in eight screens.

1) The indication (Off-On) shows whether the start/stop contact from the remote switch is open (Off) or closed (On).

F <sub>1</sub>	DIGITAL INPUT	01/08
	DI1 On-Off Remote pump	
F <sub>2</sub>	Control	
0	Off	

2) The indication (On-Off) shows whether the heating method selected from the remote switch is enabled (On) or not enabled (Off).

F <sub>1</sub>	DIGITAL INPUT	02/08
	DI2 Remote heating	
F <sub>2</sub>	Selection	
0	Off	

3) The indication (On-Off) shows whether the expansion valve is operating correctly (On) or not (Off).

F <sub>1</sub>	DIGITAL INPUT	03/08
	DI3 ok expansion	
F <sub>2</sub>	Valve	
0	On	

4) The indication (On-Off) shows whether the flow switch is detecting water circulation (On) or not (Off).

<b>F<sub>1</sub></b>	<b>DIGITAL INPUT</b>	<b>04/08</b>
	<b>DI5 Flow switch</b>	
<b>F<sub>2</sub></b>		
<b>0</b>	<b>Off</b>	

5) The indication (On-Off) shows whether the differential pressure switch is detecting water circulation (On) or not (Off).

<b>F<sub>1</sub></b>	<b>DIGITAL INPUT</b>	<b>05/08</b>
	<b>DI6 Pressure</b>	
<b>F<sub>2</sub></b>	<b>Difference switch</b>	
<b>0</b>	<b>Off</b>	

6) The indication (On-Off) shows whether the GHP outdoor unit is operating correctly (On) or if there are malfunction alarms (Off).

<b>F<sub>1</sub></b>	<b>DIGITAL INPUT</b>	<b>06/08</b>
	<b>DI9 GHP alarm</b>	
<b>F<sub>2</sub></b>		
<b>0</b>	<b>Off</b>	

7) The indication (On-Off) shows whether the GHP outdoor unit is on (On) or off (Off).

F <sub>1</sub>	DIGITAL INPUT DI11 GHP CP ON	07/08
F <sub>2</sub>		
0	Off	

8) The indication (On-Off) shows whether the GHP outside unit is defrosting (On) or not (Off).

F <sub>1</sub>	DIGITAL INPUT DI12 Defrost	08/08
F <sub>2</sub>	Control	
0	Off	

### 14.1.3 Digital outputs menu

The instructions for this submenu are shown on seven screens.

1) The indication (On-Off) shows whether the resistance simulating the air recovery temperature is set to heating (On) or cooling (Off).

<input type="checkbox"/> F <sub>1</sub>	DIGITAL OUTPUT	01/07
	DO2 Ohm resistance	
<input type="checkbox"/> F <sub>2</sub>		
<input type="checkbox"/> 0	On	

2) The indication (On-Off) shows whether the GHP outdoor unit is operating in heating (On) or cooling mode (On).

<input type="checkbox"/> F <sub>1</sub>	DIGITAL OUTPUT	02/07
	DO3 GHP heating	
<input type="checkbox"/> F <sub>2</sub>	Selection	
<input type="checkbox"/> 0	On	

3) The indication (On-Off) shows whether the pump is operating (On) or not (Off).

<input type="checkbox"/> F <sub>1</sub>	DIGITAL OUTPUT	03/07
	DO4 Pump relay	
<input type="checkbox"/> F <sub>2</sub>		
<input type="checkbox"/> 0	Off	

4) The indication (On-Off) shows whether the GHP outdoor unit control card is receiving power (On) or not (Off).

F <sub>1</sub>	DIGITAL OUTPUT DO5 Aisin PC Board	04/07
F <sub>2</sub>	Power supply	
0	On	

5) The indication (On-Off) shows whether the contact T1-T2 is closed (On GHP powered) or open (Off GHP not powered).

F <sub>1</sub>	DIGITAL OUTPUT DO7 T1-T2 PC Board	05/07
F <sub>2</sub>		
0	Off	

6) The indication (On-Off) shows whether there are alarms (On contact closed) or not (Off contact open).

F <sub>1</sub>	DIGITAL OUTPUT DO10 Alarm	06/07
F <sub>2</sub>		
0	Off	

7) The indication (On-Off) shows whether the valve is operating (On contact closed) or not (Off contact open).

<input type="checkbox"/> F <sub>1</sub>	DIGITAL OUTPUT DO12 Expansion valve	07/07
<input type="checkbox"/> F <sub>2</sub>	Driver	
<input type="checkbox"/> 0		Off

#### 14.2 Pump control

This menu serves to select the position from which to switch on the AWS. From the remote switch (**local procedure**), (select On) or directly from the control panel of the AWS (**remote procedure**), (select Off).

<input type="checkbox"/> F <sub>1</sub>	Remote pump	01/01
<input type="checkbox"/> F <sub>2</sub>	Control operation	
<input type="checkbox"/> 0		On



### 14.3 Mode selection

This menu serves to select the position from which to select the cool/heat operating mode. Directly from the control panel of the AWS (select On). From the remote switch (select Off).

F <sub>1</sub>	Heating/cooling	01/01
F <sub>2</sub>	Local selection	
0	On	

### 14.4 Toffset cooling

This menu serves to select the number of degrees by which the cooling water temperature needs to rise before the GHP outside unit starts up again

F <sub>1</sub>	Toffset setpoint	01/01
F <sub>2</sub>	Cooling	
0	2.0 °C	

### 14.5 Toffset heating

This menu serves to select the number of degrees by which the heating water temperature needs to fall before the GHP outside unit starts up again

F <sub>1</sub>	Toffset setpoint	01/01
F <sub>2</sub>	Heating	
0		2.0 °C

**14.6 Pump delay**

This menu serves to select the amount of time the AWS pump needs to stay on before switching off once the GHP outside unit has stopped.

F <sub>1</sub>	Pump delay	01/01
F <sub>2</sub>		
0		180 Sec.

## 15 Disabling the flow switch alarm

It is possible to disable the flow switch alarm as follows:

Select the programming mode menu

<input type="checkbox"/> F <sub>1</sub>	MENU	01/01
	User mode	
<input type="checkbox"/> F <sub>2</sub>		
	Service mode	
<input type="checkbox"/> 0	Programming mode	

Select "Password"

<input type="checkbox"/> F <sub>1</sub>	PROGRAMMING MOD	01/01
	Password	
<input type="checkbox"/> F <sub>2</sub>		
	Configuration mode	
<input type="checkbox"/> 0		

The following page will open.

<input type="checkbox"/> F <sub>1</sub>	PASSWORD
<input type="checkbox"/> F <sub>2</sub>	
	*****
<input type="checkbox"/> 0	

Use the “OK” key to select the first asterisk \*. When the asterisk begins to flash, press the top key on the selection keypad. The + sign will appear in place of the asterisk.

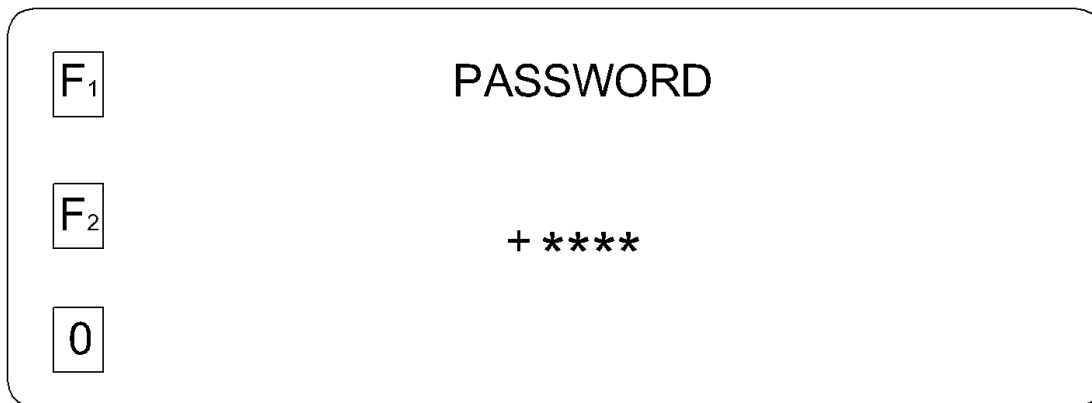

Press the “OK” key again to confirm the selection and return to the “MENU” page.

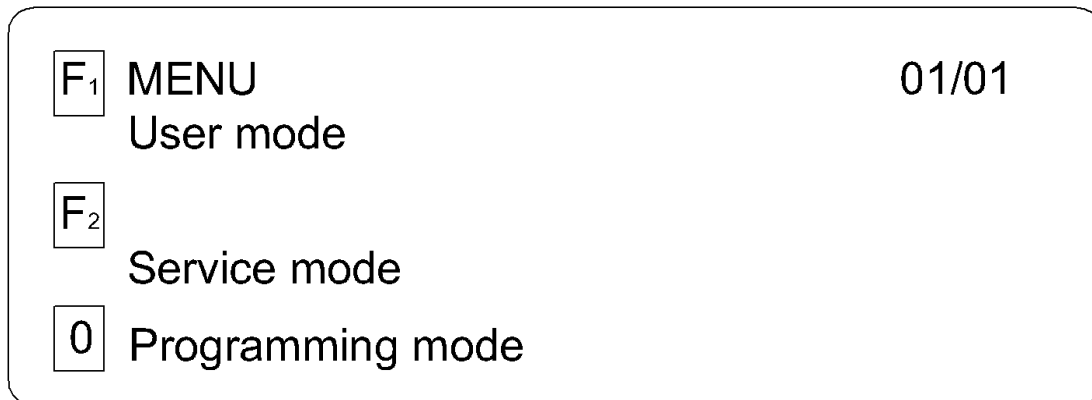

**Select “Service mode”.**

Note: It is not possible to de-activate the flow switch alarm directly from the service menu without first selecting the password in the programming menu.

Select the page 03/03

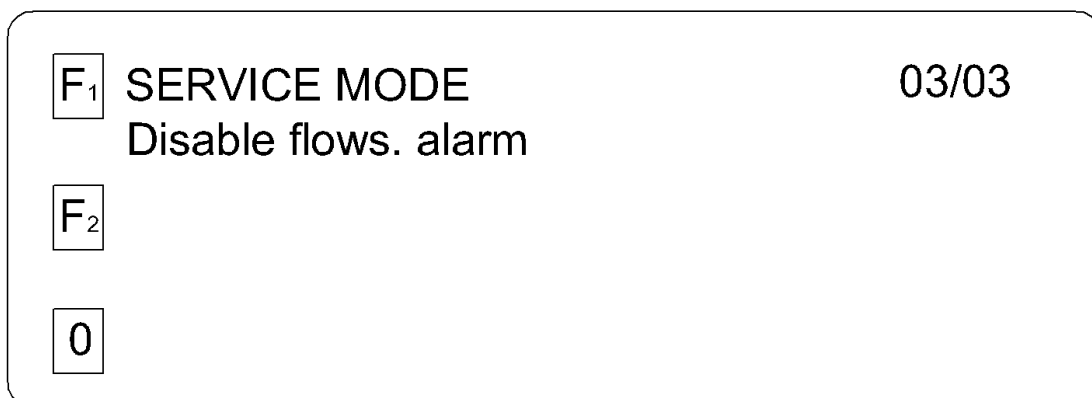

Select “**Disable flows. alarm**” to open the following page,

<input type="checkbox"/> F <sub>1</sub>	Flow switch tampering	01/01
<input type="checkbox"/> F <sub>2</sub>	Alarm disable	
<input type="checkbox"/> 0	Off	

“Off” means that the flow switch alarm has been engaged. To switch it off, select “Off”. When the message starts to flash, press the top button on the select keypad to engage “On” and disable the alarm. Press “OK” to confirm the choice.

## 16 Wiring diagrams

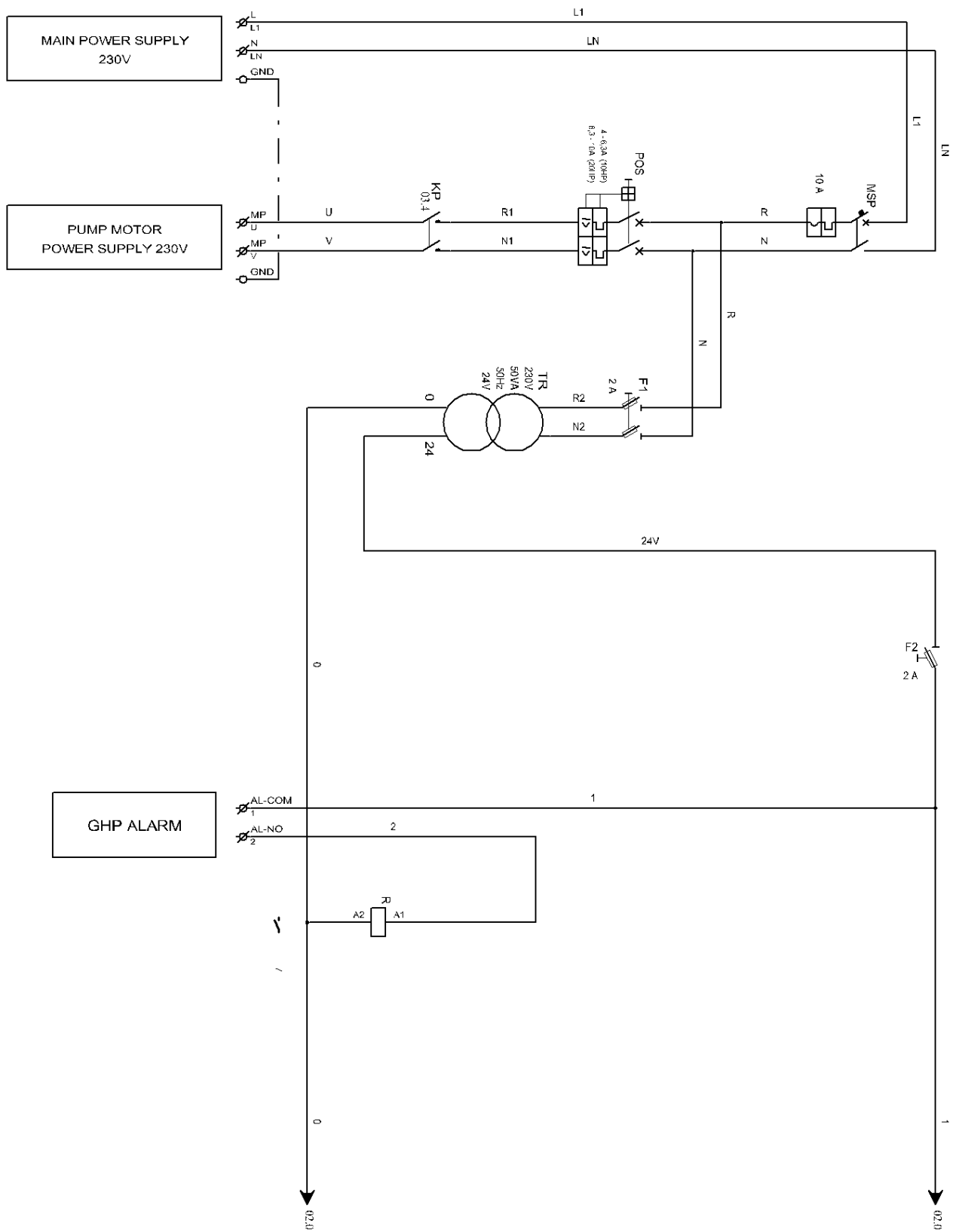

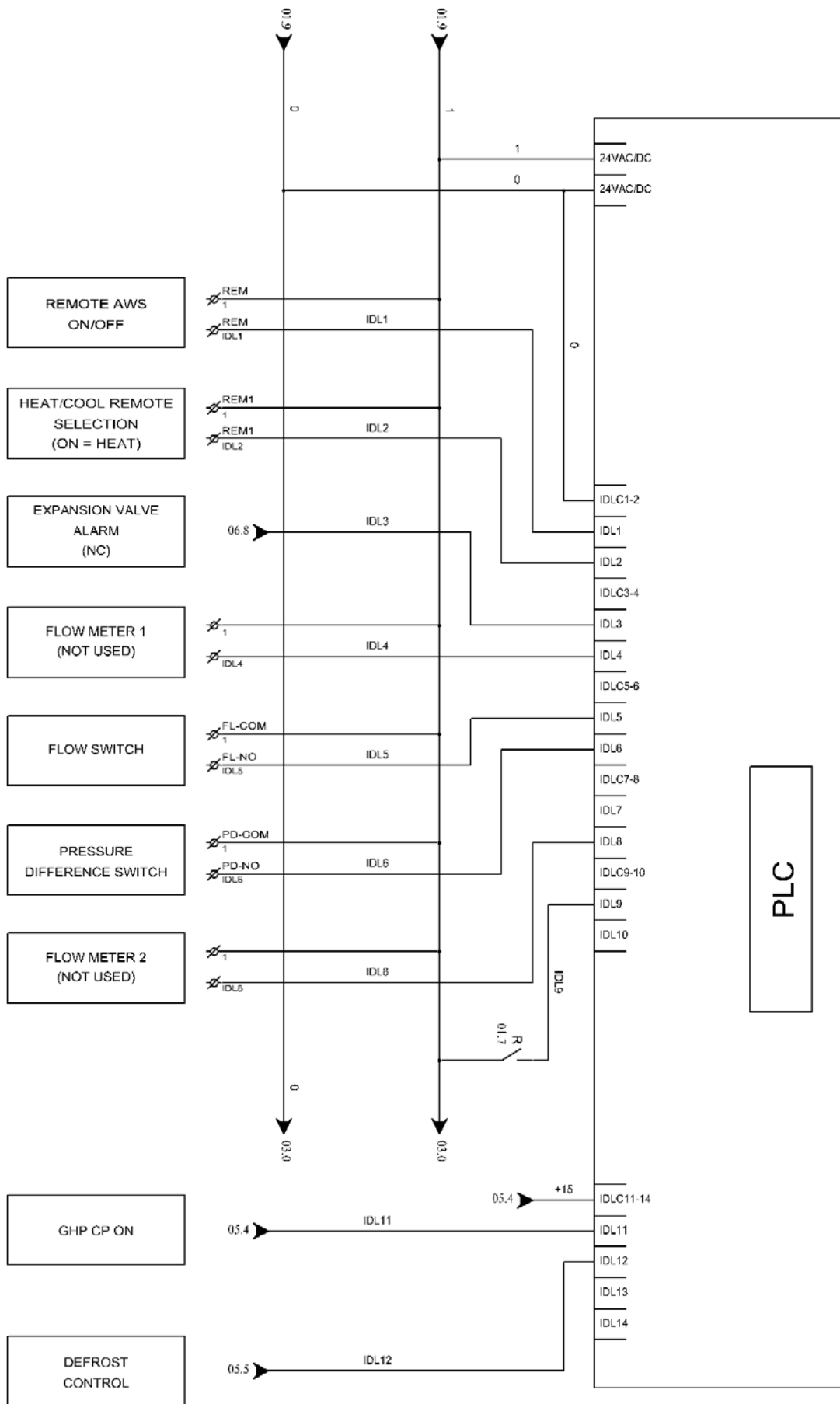

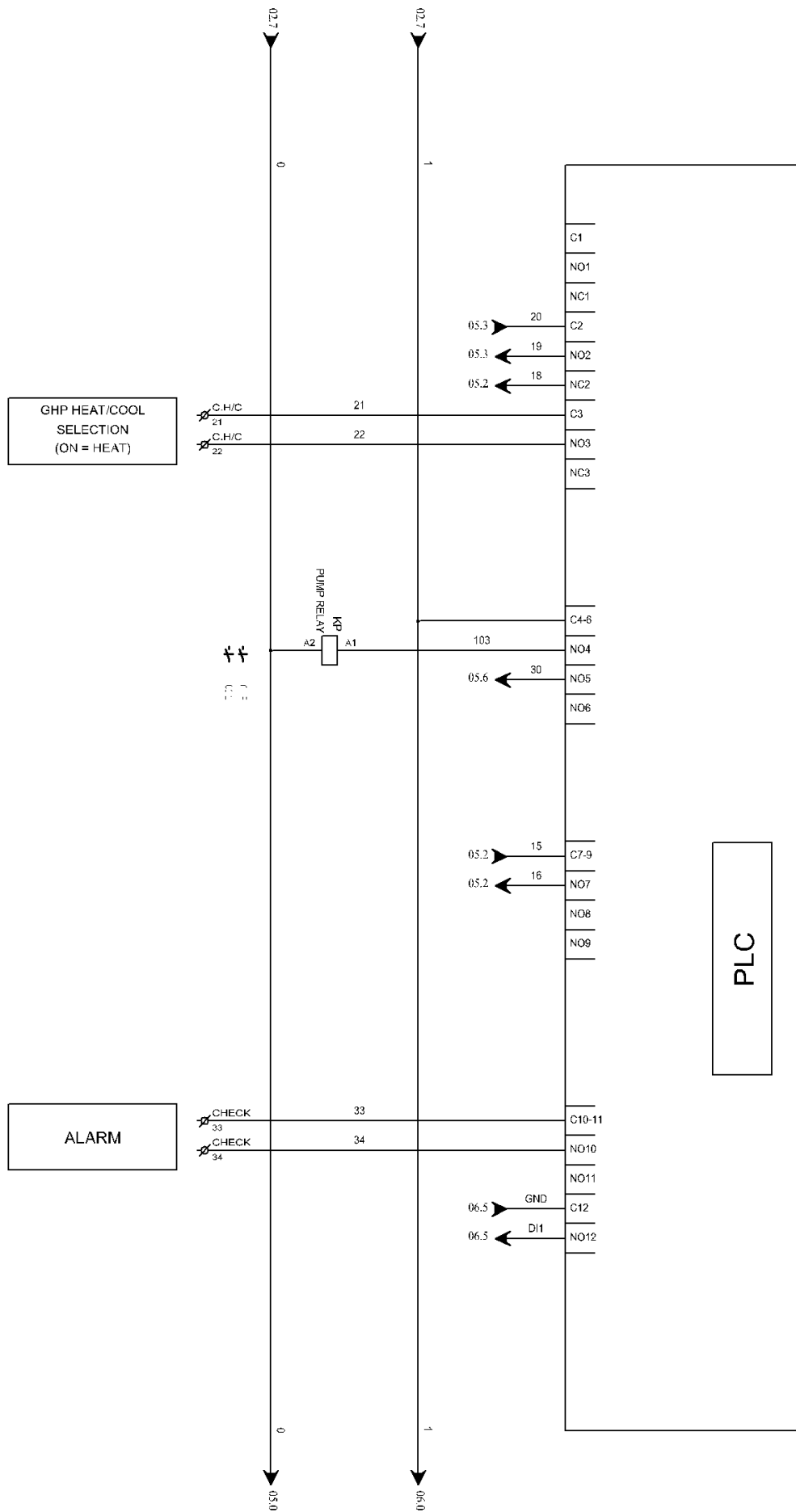



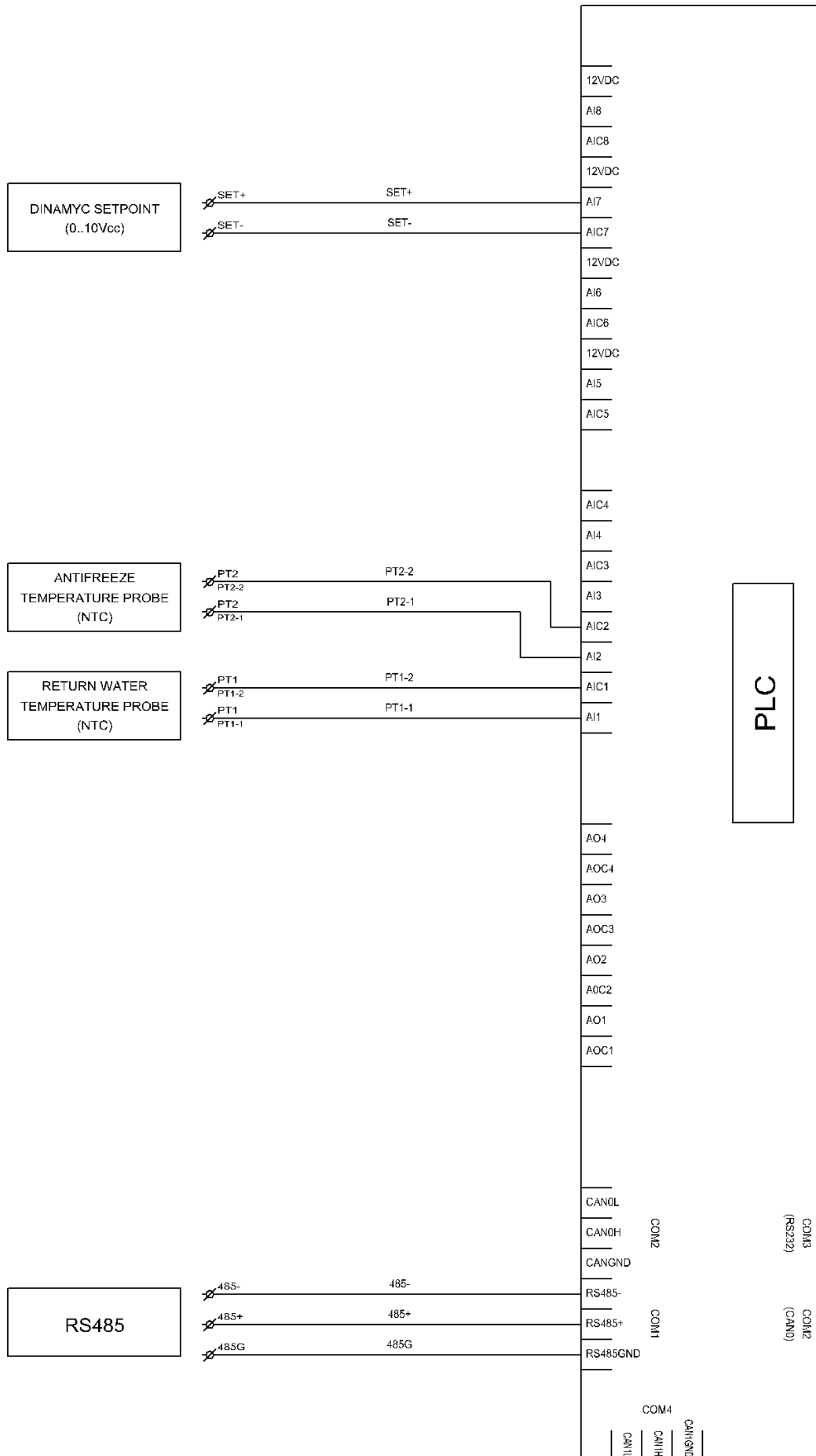

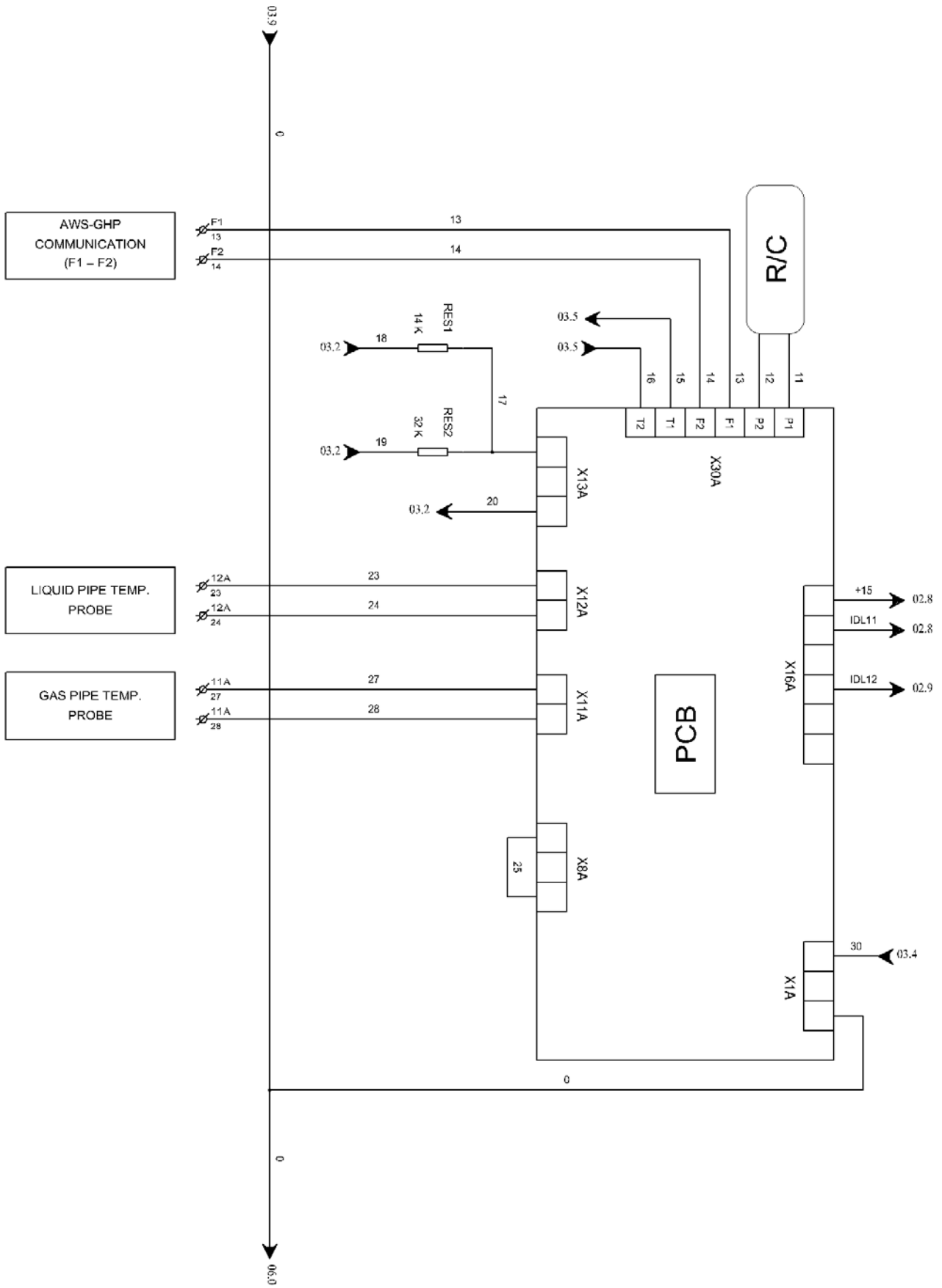

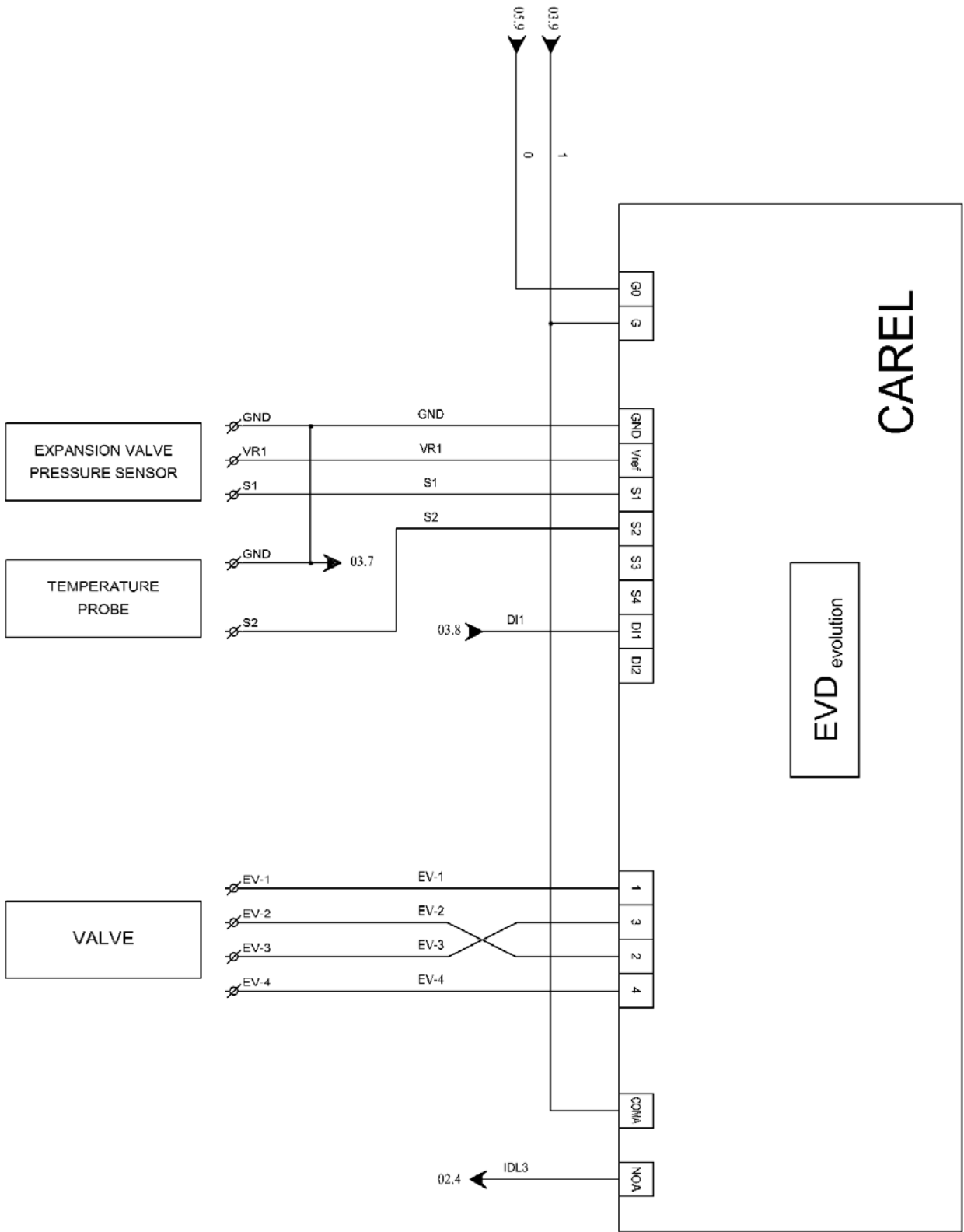

# 17 Relation between engine RPM and outside temperature

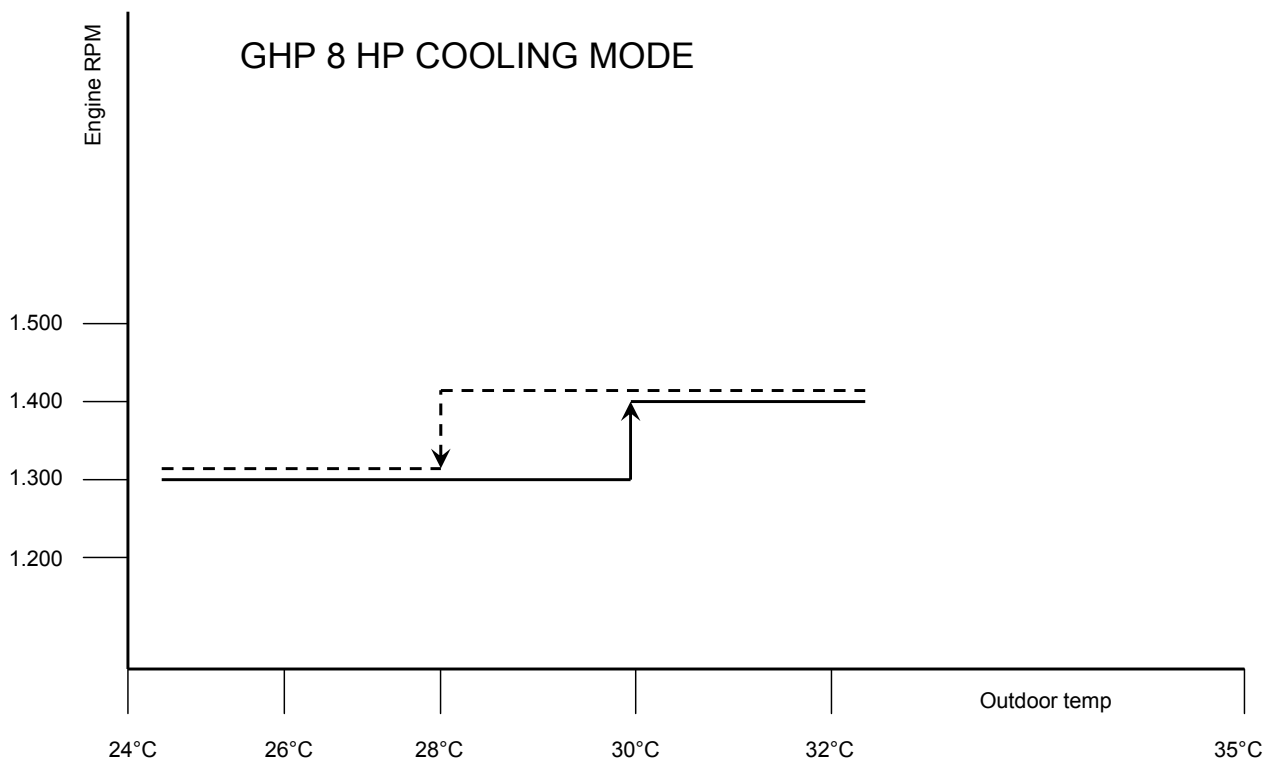
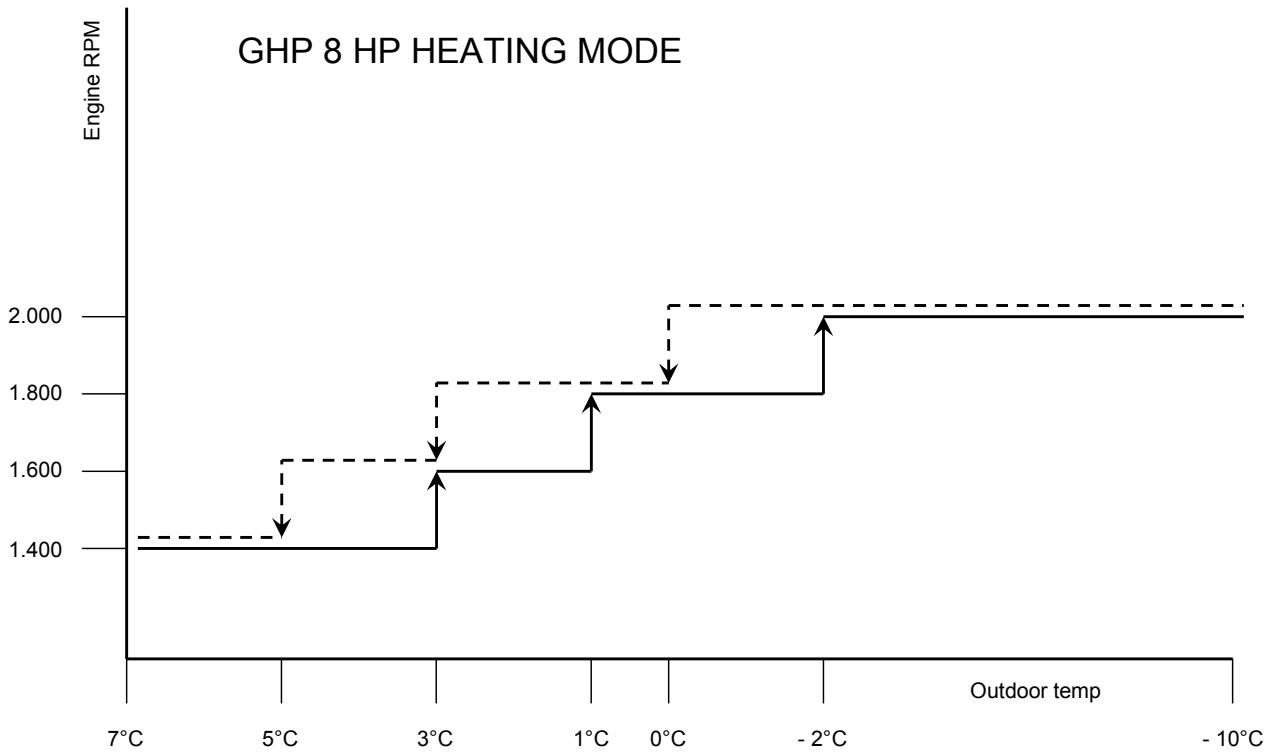

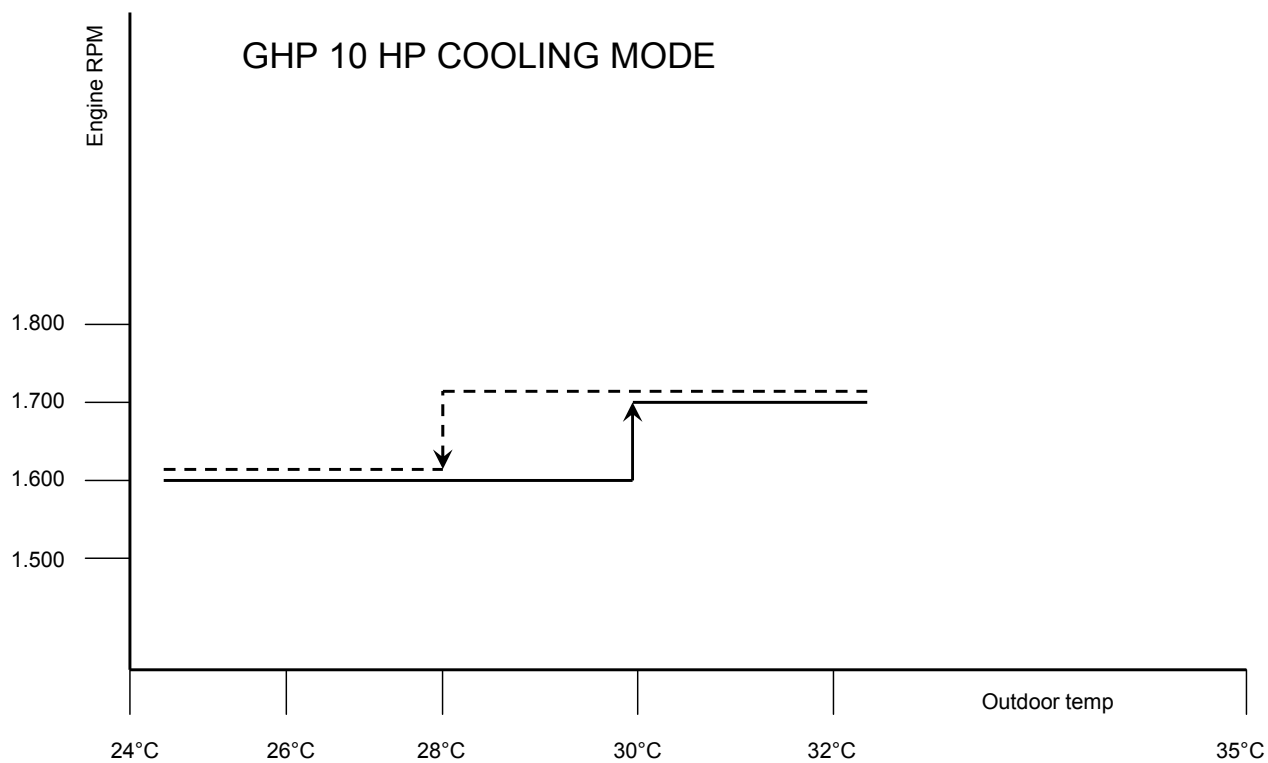
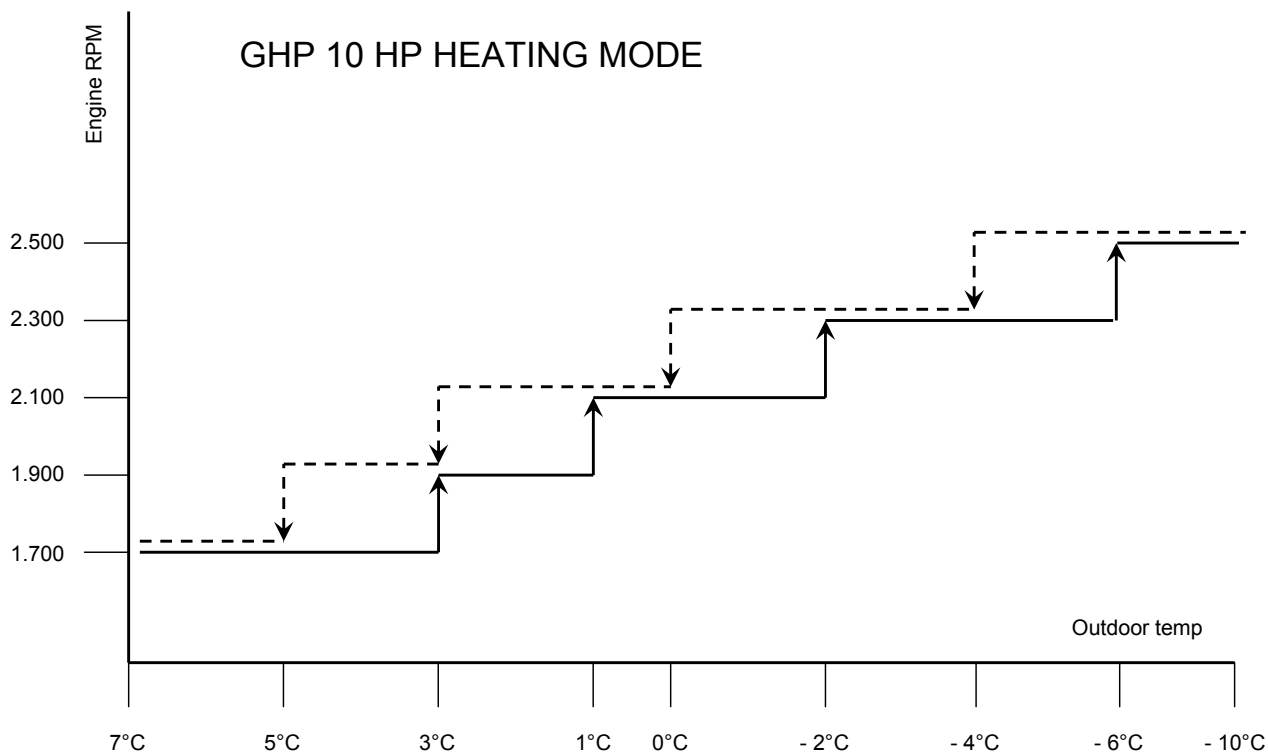

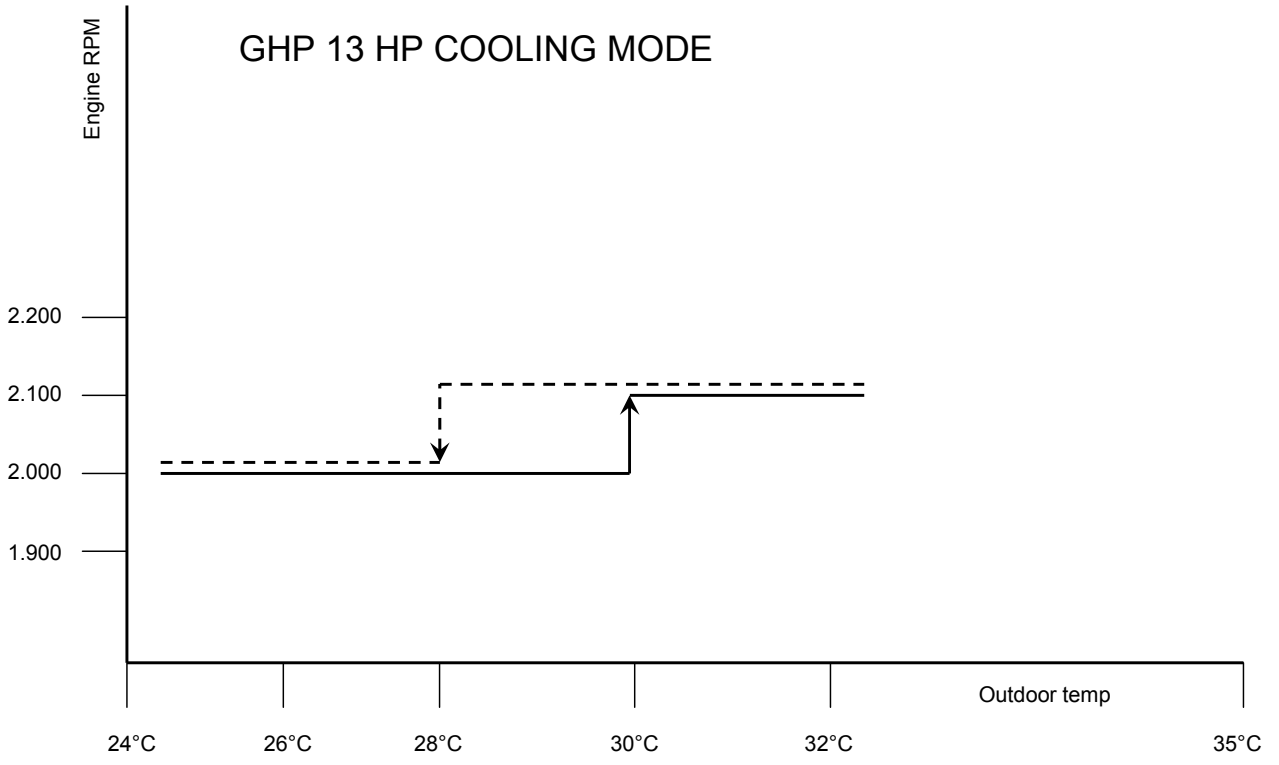
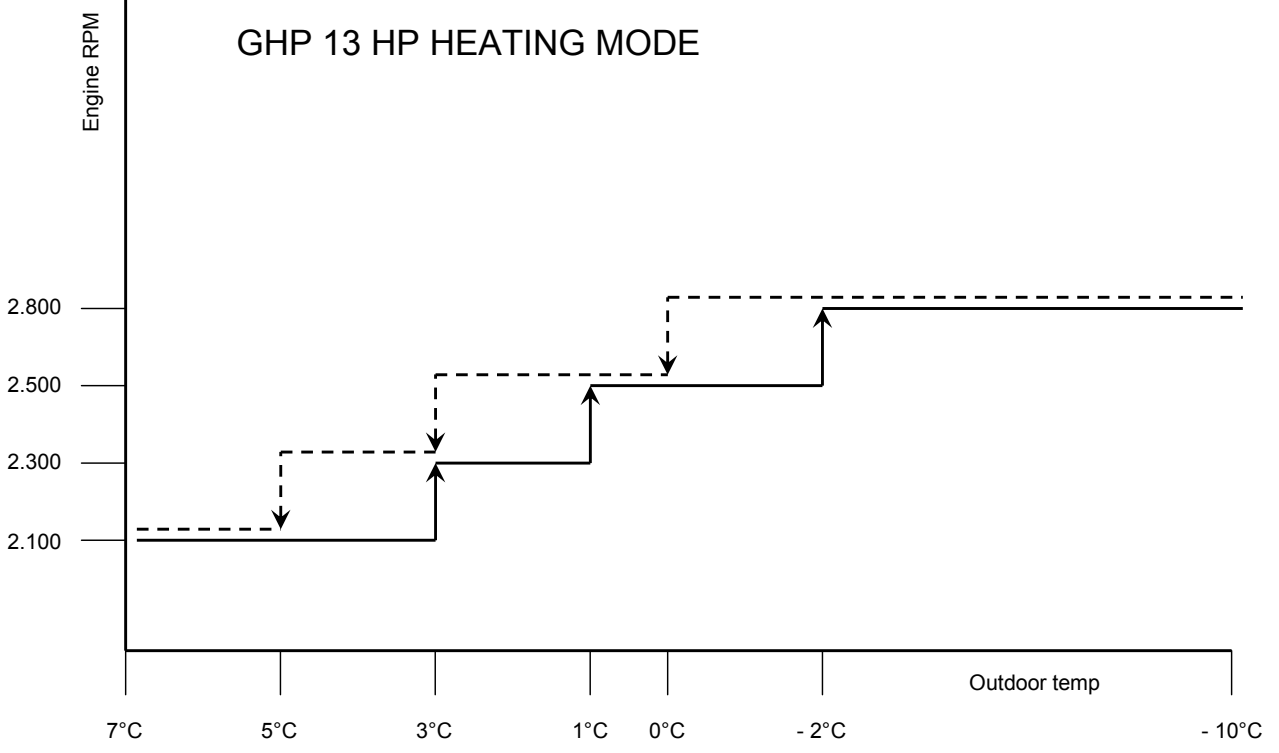

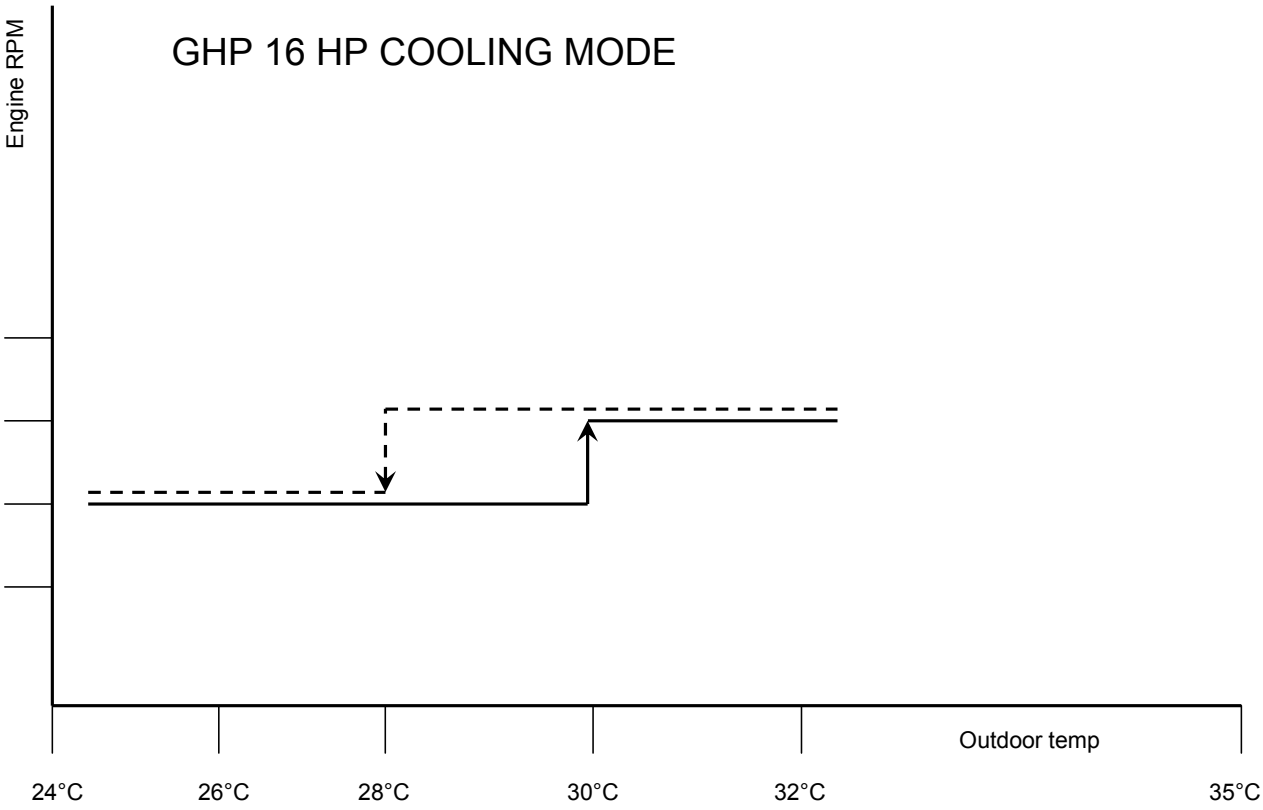
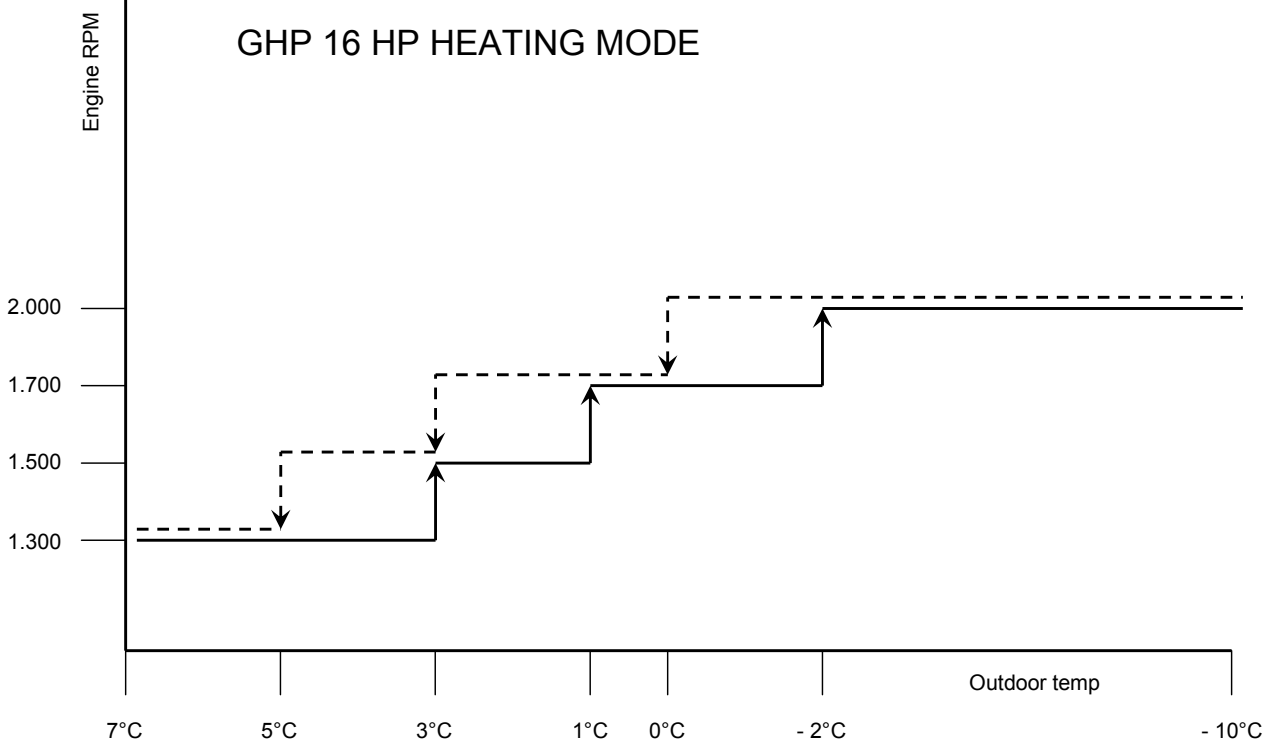

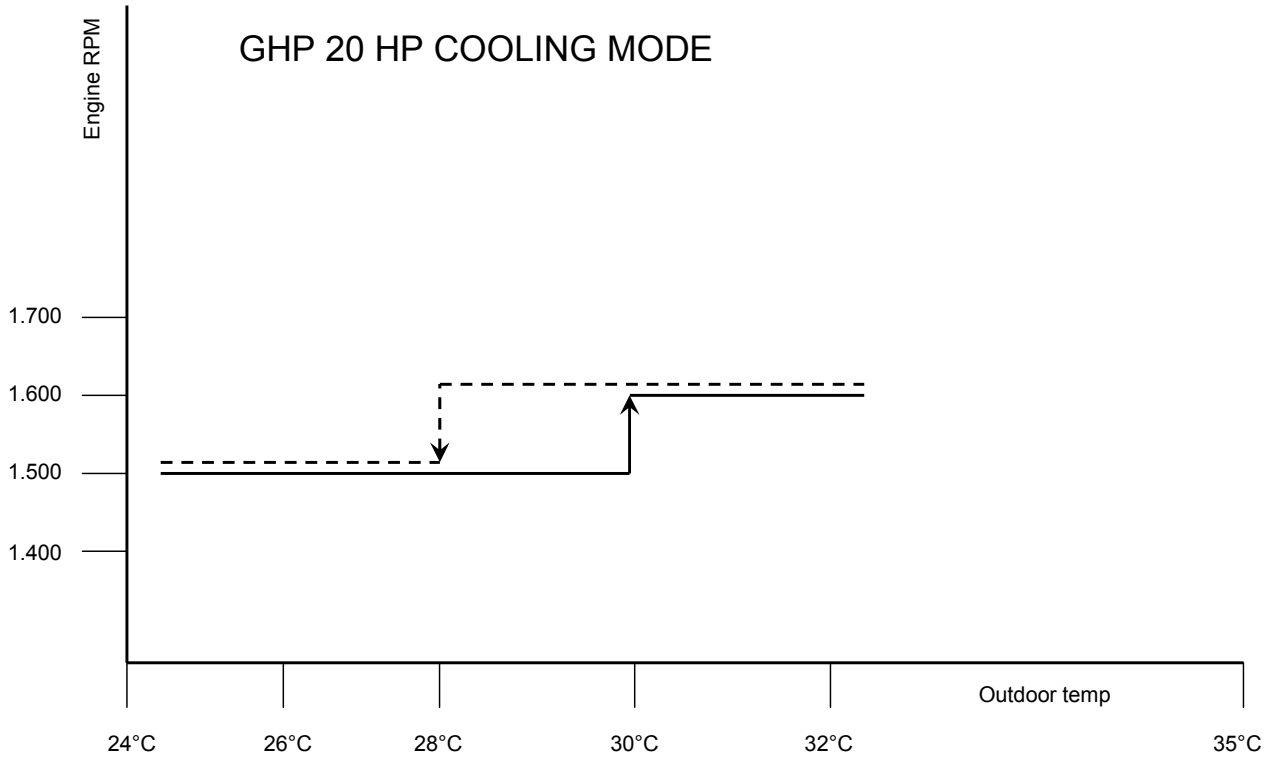
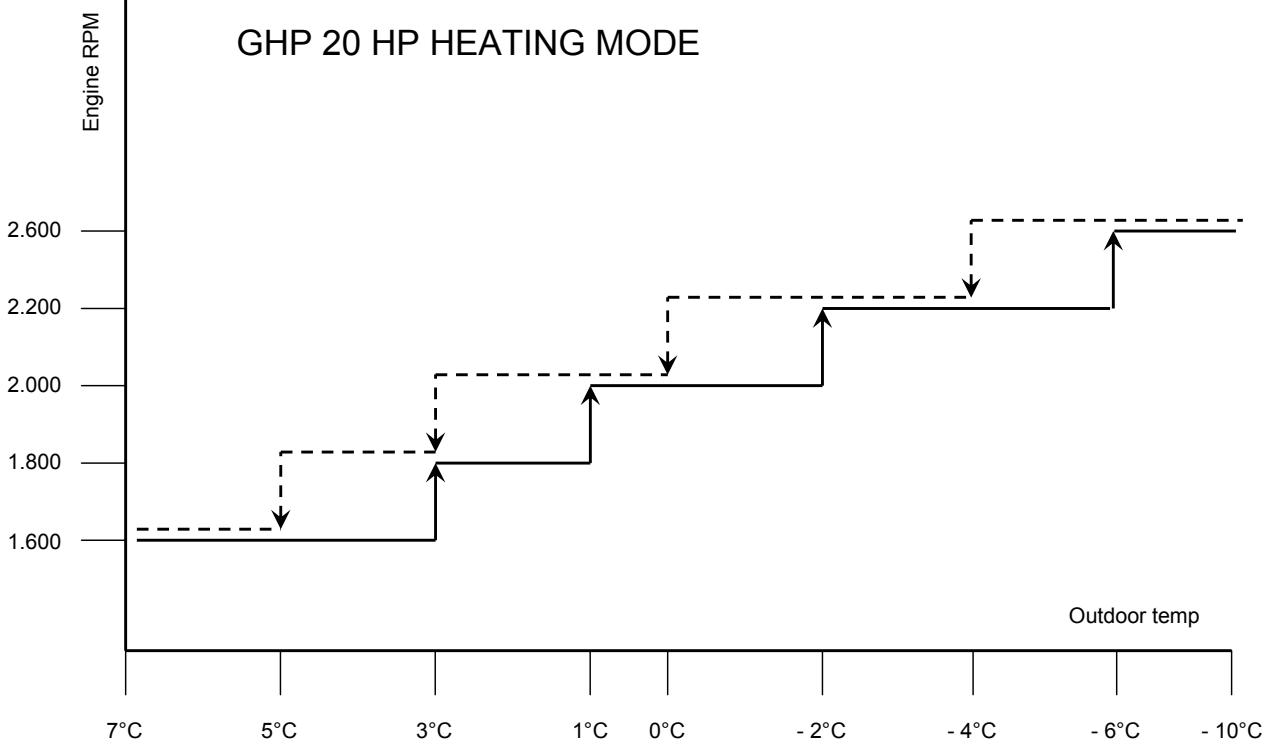



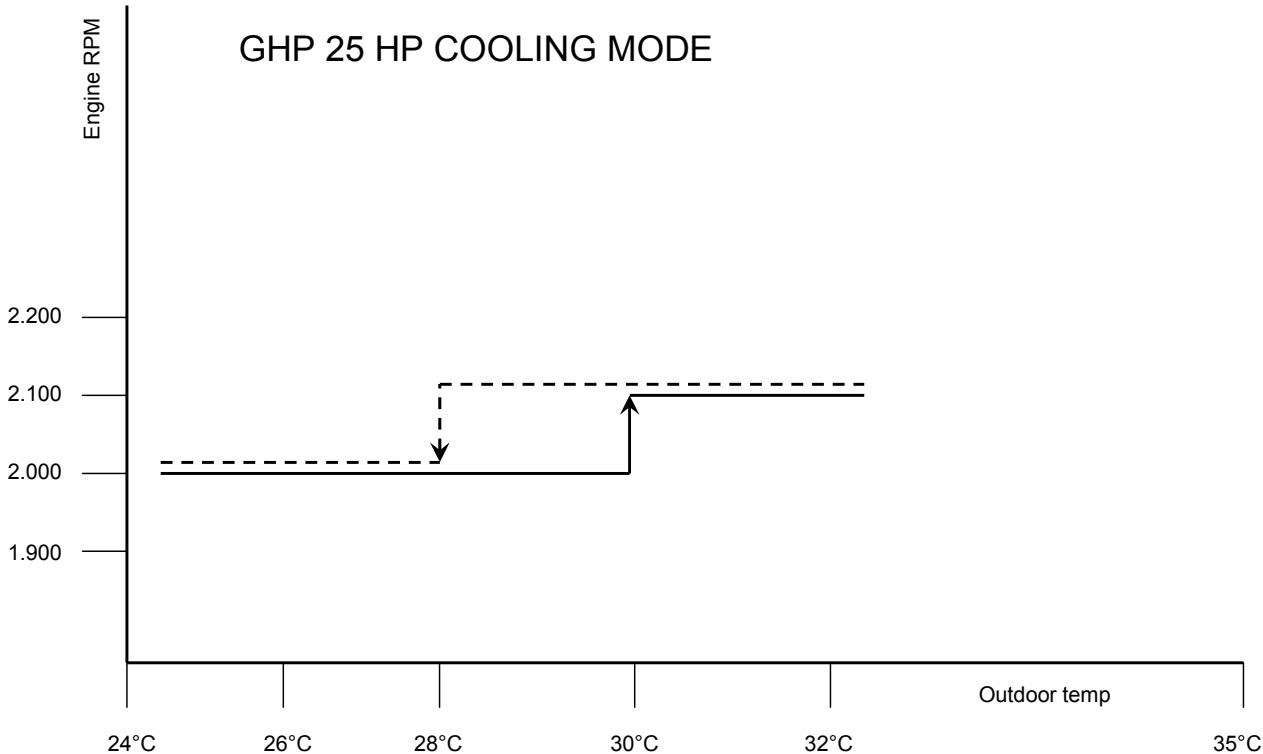
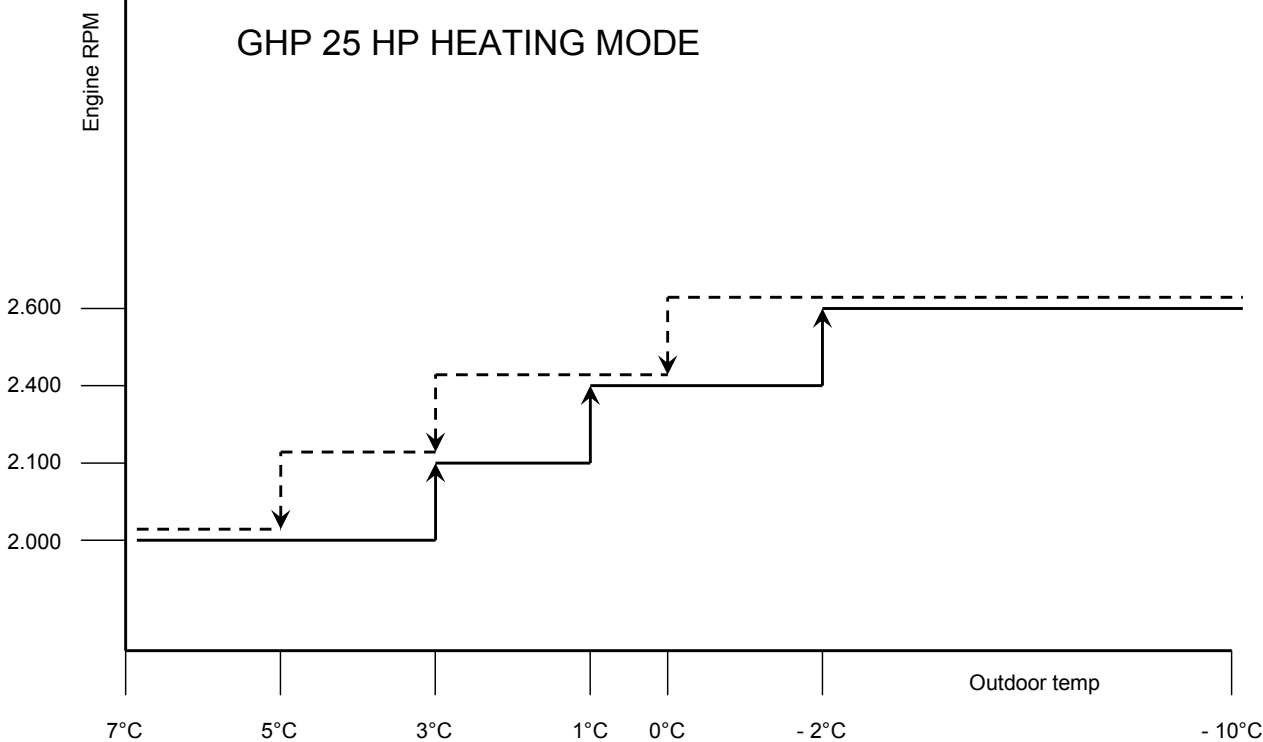

## 18 Contact specifications

### Digital Input

AL-COM AL-ON	Dry contact (closed 0 Volt – open 24 VAC)
REM	Dry contact (closed 0 Volt – open 24 VAC)
REM1	Dry contact (closed 0 Volt – open 24 VAC)
FL-COM FL-ON	Dry contact (closed 0 Volt – open 24 VAC)
PD-COM PD-ON	Dry contact (closed 0 Volt – open 24 VAC)
IDLC11-14 IDL11 ( From the board to the PLC )	15 VDC
IDLC11-14 IDL12 ( From the board to the PLC )	15 VDC

### Digital Output

KP (pump relay)	Open 24 VAC
C H/C	Dry contact ( closed 0 Ohm)
C7-9 NO13 (contact T1 T2)	Dry contact ( closed 0 Ohm)
C13-15 NO13 (contact DI1 Valve Driver)	Dry contact ( closed 0 Ohm)
Alarm	Dry contact ( closed 0 Ohm)
C4-6 NO5 (Power supply board)	Dry contact ( closed 0 Ohm)

### Components

PCB – connector X1A	When supplied 24 VAC
Driver Valve GoG	When supplied 24 VAC
Pump	When supplied 230 VAC single phase

### Analogic Input

NTC probe	See “table resistor temperature sensor values NTC”
Probe 4-20 mA Pressure	Linear 4 mA = 0 BAR 20 mA = 44,8 BAR

**19 Table temperature - sensor NTC resistor**

Temperature °C	Resistance value		
	KΩ	KΩ	KΩ
-5	34,66	33,90	33,15
-4	33,15	32,44	31,73
-3	31,72	31,05	30,39
-2	30,36	29,73	29,11
-1	29,06	28,48	27,89
0	27,83	27,28	26,74
1	26,65	26,13	25,62
2	25,52	25,03	24,55
3	24,44	23,99	23,54
4	23,42	23,00	22,57
5	23,42	23,00	22,57
6	21,53	21,15	20,78
7	20,64	20,30	19,95
8	19,81	19,48	19,15
9	19,01	18,70	18,39
10	18,25	17,96	17,67
11	17,51	17,24	16,97
12	16,81	16,56	16,30
13	16,14	15,90	15,67
14	15,50	15,28	15,06
15	14,89	14,69	14,48

## 20 Characteristics sensor gas and liquid pipe

### SENSOR GAS PIPE

Temperature (°C)	Resistance ( $\Omega$ )
-10	112.0 k
0	65.8 k
10	40.0 k
20	25.0 k
30	16.1 k
40	10.6 k
50	7.2 k

### SENSOR LIQUID PIPE

Temperature (°C)	Resistance ( $\Omega$ )
-10	112.0 k
0	65.8 k
10	40.0 k
20	25.0 k
30	16.1 k
40	10.6 k
50	7.2 k



# YOSHI®

Experience & Technology

CE

# AISIN



**ANIMA®**

